

HARDSCAPES & MASONRY



POLYCOR
NATURAL STONE

FIELD BINDER



OUTDOOR LIVING SPACES MADE BY NATURE

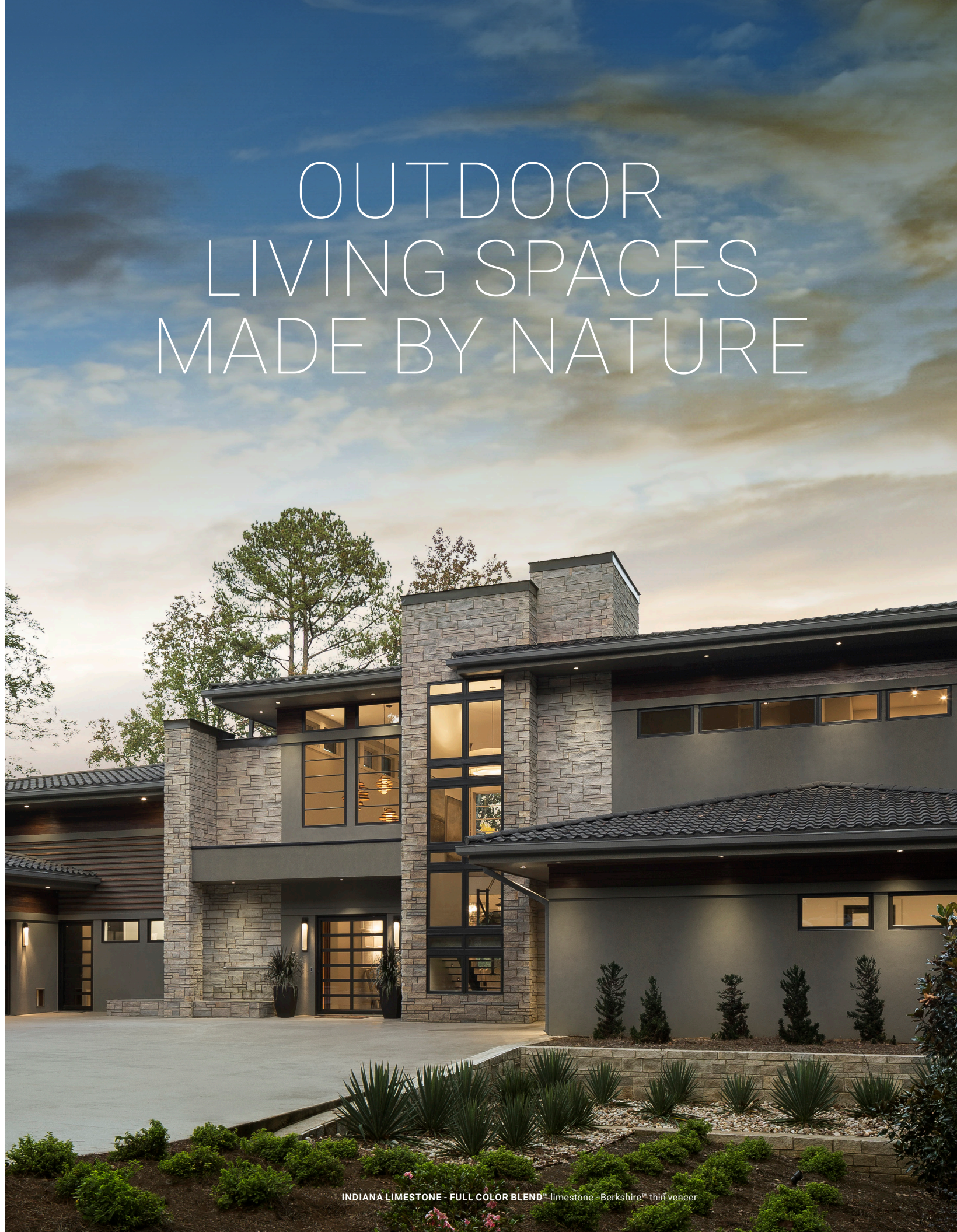

7 Our Story

10 Our Quarries

11 Our Value Proposition

12 Polycor U

13 Design Tools

14 Authorized Dealer
and Contractor Programs

16 Our Stones **NEW**

19 Estate Veneer Series

20 Berkshire™

22 Rockford Estate Blend™

24 Vanderbilt Classic™

26 Sills

28 Veneer Installation Guide **NEW**

50 Veneer Coursing Diagram **NEW**

55 Walkways & Patios

56 Pavers **NEW**

58 XL Pavers **NEW**

60 Pattern Pavers **NEW**

69 Paver Installation Guide **NEW**

72 Pool Coping **NEW**

75 Steps & Treads

76 6" Steps

78 Treads

81 Walls & Caps

82 Garden Walls

84 Wall Caps

86 Pillar Caps

89 Outdoor Elements

90 Round Fire Pit

92 Square Fire Pit

95 Fire Pit Installation Guide

101 Technical Data

102 ASTM Test Results **NEW**

106 SRI Test Results **NEW**

109 Care and Maintenance

110 Limestone Care and Maintenance

112 Granite Care and Maintenance

114 Marble Care and Maintenance

120 Collection Charts



SUCCESS IS BUILT ON *passion*

Polycor is a North American natural stone quarrier and fabricator. By joining forces with other industry pioneers, we provide our customers with centuries of stone expertise. Our vision is to establish new foundations of global leadership by setting the standard for excellence in sustainable natural stone. Our products are built to last so that future generations can continue to fall in love with natural stone.

Workers in Indiana standing on a limestone column, 1921.



GLOBAL
WITH A *local*
FOOTPRINT

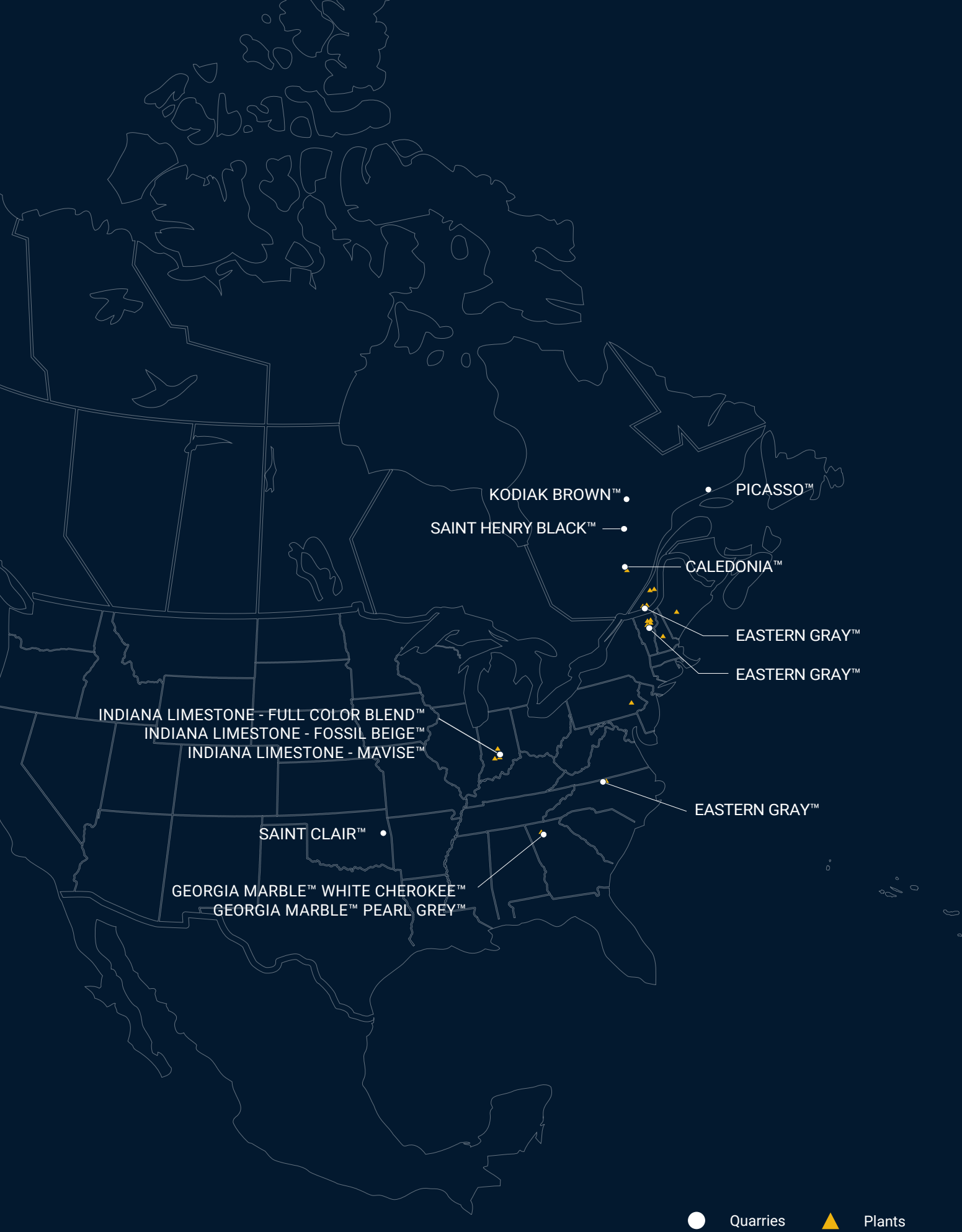

QUARRIED
IN NORTH
AMERICA

QUARRY
& PLANT
OWNER

QUALITY
CONTROL

SUSTAINABLE

BLENDS
WITH
NATURE

DURABLE

RESISTS
FREEZE-
THAW
CYCLES

GREATER
AVAILABILITY
& SHORTER
LEAD TIME

VIRTUALLY
MAINTENANCE
FREE

DESIGN
FLEXIBILITY

BALANCE
BETWEEN
AESTHETIC
& PERFOR-
MANCE

ADAPTABLE
TO ANY
PROJECT



FREE

LEAVE NO STONE UNTURNED

Check out our latest courses for hardscape professionals.

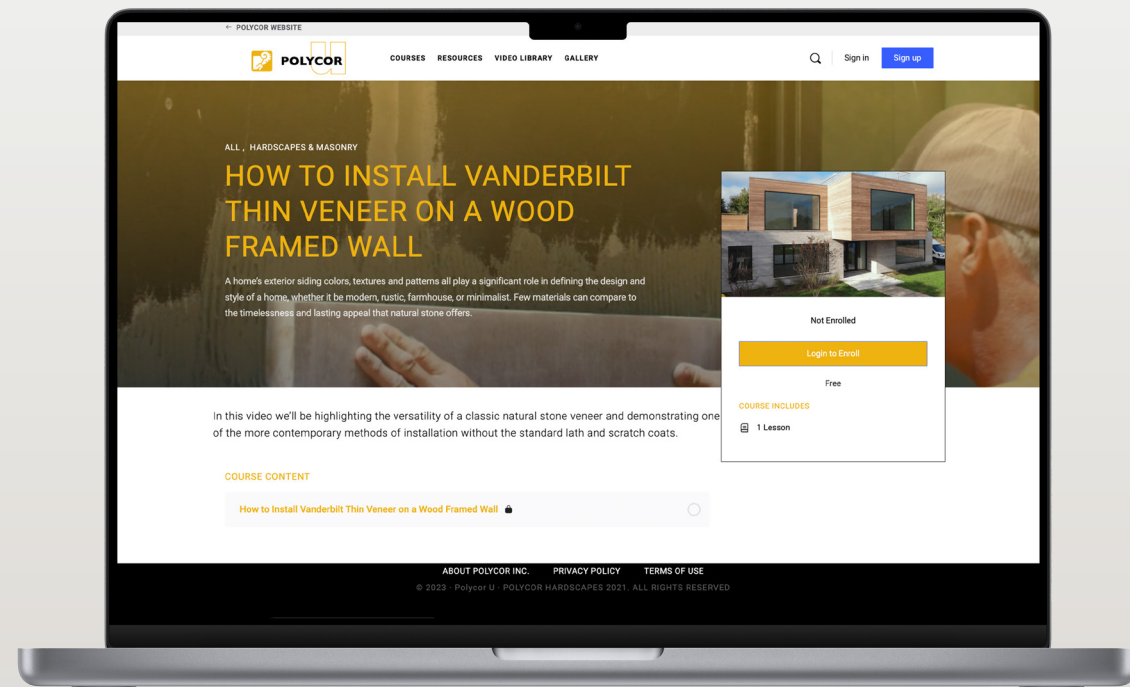

Scan this QR Code for quick access to our educational platform: learn.polycor.com



NEW 3D TOOLS



113 textures

Ultra-calibrated colors
4 different natural stones
8K Ultra-High Definition

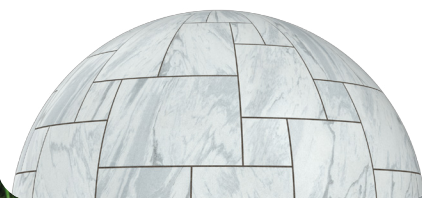

Free to download



1. Scan QR code or go to:
polycor.com/resources/3d-textures

2. Download free 3D high-resolution textures

3. Create photorealistic renders!

360° Product Viewer



This innovative tool gives prospects the opportunity to examine our product in an interactive way.



AUTHORIZED CONTRACTOR PROGRAM

Becoming an authorized contractor comes with several benefits:

- Lead referrals from our team and our dealers
- Annual Polycor Master Craftsman Awards Program
- On-site training and technical support
- Credit on trade show materials
- Quarry tour events and continuous training through education seminars

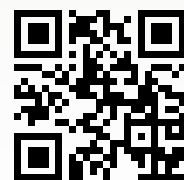

Scan this QR Code for quick access to our **Authorized Contractor Program**.



AUTHORIZED DEALER PROGRAM

Becoming an authorized dealer comes with several benefits:

- Increase your sales
- Improve your customer satisfaction
- Gain exposure to new customers



Scan this QR Code for quick access to our **Authorized Dealer Program**.

OUR STONES



INDIANA LESTONE - FULL COLOR BLEND™ limestone
A natural, full range compilation of warm buff colors and medium gray tones are present within this historic limestone quarried in Indiana. Its dense, compact grain structure gives it a marble-like quality, making it the perfect choice for outdoor living spaces.

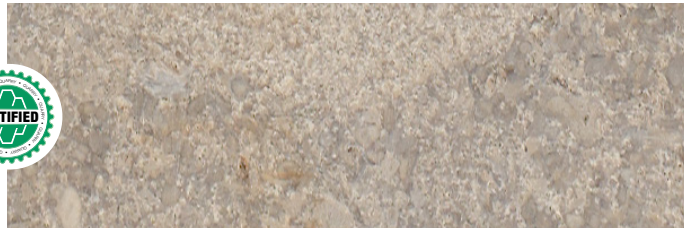

INDIANA LESTONE - FOSSIL BEIGE™ limestone
Quarried in Indiana, this limestone has finely blended ripples of beige and grey that provide a neutral backdrop to small shell inclusions and occasional russet-colored flakes. Subtle veining meanders throughout the surface creating a unique movement in this medium grained stone.

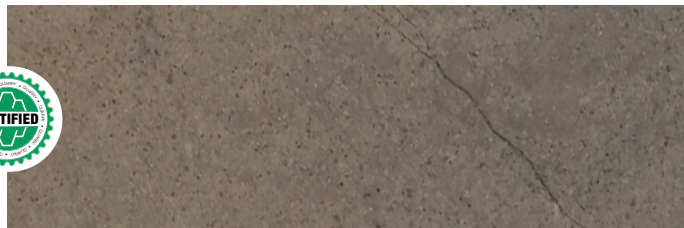

INDIANA LESTONE - MAVISE™ limestone **NEW**
This unique limestone, extracted from Polycor's exclusive quarry in Indiana, is highly adaptable for a variety of applications. It exhibits the robustness and density commonly found in top-quality materials, and its distinctive coloring resembles that of marble, offering both durability and one-of-a-kind veining and color patterns. Mavise is a perfect choice for projects aiming to make a bold design statement, introducing an element of exceptional elegance and charm to any space.



CALEDONIA™ granite
Quarried in Québec, this granite is a true Canadian emblem. Its dark backdrop is mottled with flecks in various shades taupe and gray. Recognized for its color consistency, this granite is an ideal choice for projects to be completed in multiple phases.

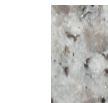

EASTERN GRAY™ granite
This granite is truly exceptional, sourced from three distinct quarries in North America. The beautiful light to medium gray color with a mid-size coarse grain is consistent across all slabs. Its striking features will add to the aesthetic appeal of any project.

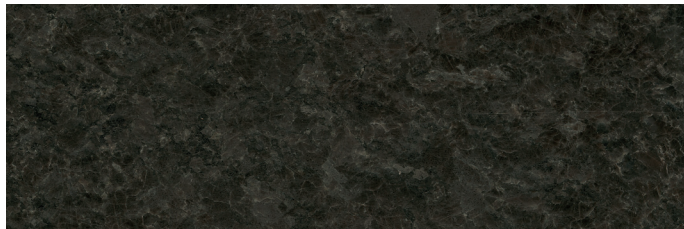
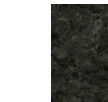

KODIAK BROWN™ granite **NEW**
Unearthed in the mountainous countryside of Québec, this granite has a delectable combination of chocolaty tones punctuated by small, pale flakes. Its multifaceted undertones bring a gentle sophistication to any space.

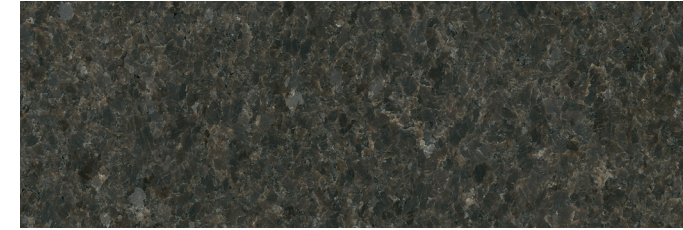

PICASSO™ granite **NEW**
With its neutral hues, this beautiful Canadian stone is a Polycor exclusivity. Consistent and homogenous in color, it is easy to work this stone from every angle. It is recognizable for its neutral background color and thin orange surface veins.

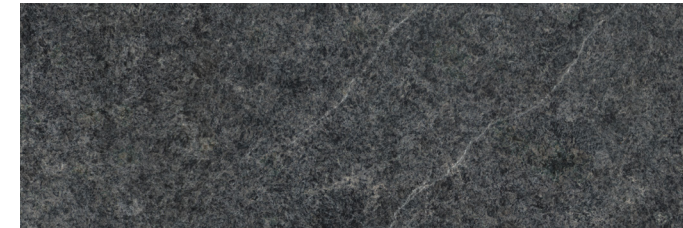

SAINT HENRY BLACK™ granite
Yet another gem from Québec, this granite is a tapestry woven with oversized, eye-catching metallic crystals, imbuing this classic stone with a touch of contemporary sophistication.



GEORGIA MARBLE™ PEARL GREY™ marble
The consistent grain structure of this North American marble contributes to its strength and resistance. Its white, gray, and black veins creates a dramatic statement that immediately draws the eye, making it the star attraction of any space.



GEORGIA MARBLE™ WHITE CHEROKEE™ marble **NEW**
This marble comes from an extensive quarry that has been operated for more than a century. Stylish, it is one of the most homogenous marbles, and is used in large architectural projects and American heritage building restorations.



SAINT CLAIR™ marble, fleuri cut **NEW**
This monochromatic marble features a captivating wavelike pattern that evolves from one slab to the next. Depending on the stone's cut, the slabs unveil subtle gradations of gray and beige, with delicate dark veins in a mesmerizing, cloud-like design in a fleuri cut.

ESTATE VENEER SERIES

Beauty and permanence combined.

Embellish new builds with stately elegance or refresh an existing home by adding a classic touch. Polycor veneers are available in traditional full-bed veneer or thin veneer cladding. The Estate Veneer Series is available in a variety of stones, shapes, and sizes.

Berkshire™	20
Rockford Estate Blend™	22
Vanderbilt Classic™	24
Sills	26
Veneer Installation Guide NEW	28
Veneer Coursing Diagram NEW	50



ROCKFORD ESTATE BLEND™

PRODUCT DATA SHEET



Scan me for more info.

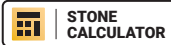

INDIANA LIMESTONE - FULL COLOR BLEND™
Limestone - Rockford Estate Blend™ thin veneer

Rockford Estate Blend™ is a lightly tumbled, genuine natural stone veneer. It provides a full range of natural colors and sizes to accentuate the architectural style of each application. Available in both thin and full-bed veneer.

THIN VENEER FLATS

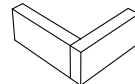

Height	Depth	Length
2" - 12"	¾" - 1 ¼"	4" - 20"

THIN VENEER CORNERS

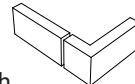

Height	Depth	Length
2" - 12"	3" - 4"	4" - 12"

FULL-BED VENEER FLATS*

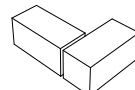

Height	Depth	Length
2" - 12"	3" - 5"	Variable

*Each piece of full-bed veneer can be used as a corner

STONES

- INDIANA LIMESTONE - FULL COLOR BLEND™**
Limestone - Tumbled
- INDIANA LIMESTONE - FOSSIL BEIGE™**
Limestone - Tumbled

ROCKFORD ESTATE BLEND™

PACKAGING INFORMATION

THIN VENEER FLATS

Products	Size	Thickness	Quantity per crate	Units per crate	Weight per crate (Lbs) Limestone
Pre-packaged mixed	2"-12" x 4"-20"	¾" - 1 ¼"	Small crate 25 sq. ft.	Varied	325
			Large crate 150 sq. ft.	Varied	1,950

CORNERS

Pre-packaged mixed	2"-12" x 4"-12"	3" - 4"	Small crate 25 ln.ft.	Varied	325
			Large crate 150 ln.ft.	Varied	1,950

FULL-BED VENEERS FLATS

Products	Size	Thickness	Quantity per crate	Units per crate	Weight per crate (Lbs) Limestone
Pre-packaged mixed	2"-12" x Varied	3" - 5"	45 sq. ft. per ton	Varied	3,000 - 4,000

VANDERBILT CLASSIC™

PRODUCT DATA SHEET



Scan me for more info.

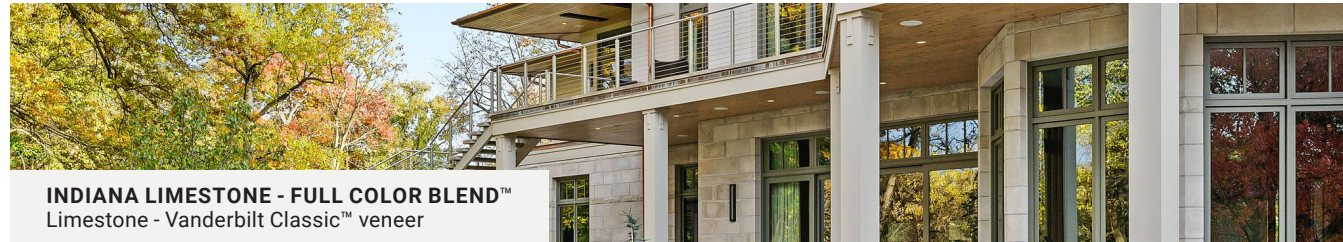

The strong, clean look of Vanderbilt Classic™ veneer is ideal for commercial and fine residential buildings. Available in both thin and full-bed veneer.

THIN VENEER FLATS

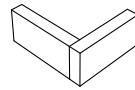

Height	Length
3 5/8"	23 5/8"
7 5/8"	23 5/8"
11 5/8"	23 5/8"
15 5/8"	23 5/8"

Depth varies per type of stone.
Limestone 1 3/16" - Granite 1" - Marble 25/32"

THIN VENEER CORNERS¹

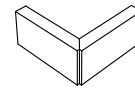

Height	Length	Quirk Miter Corners
3 5/8"	23 5/8"	
7 5/8"	23 5/8"	
11 5/8"	23 5/8"	
15 5/8"	23 5/8"	

Depth varies per type of stone.
Limestone 1 3/16" - Granite 1" - Marble 25/32"
¹ 2 Quirk Miter Corner pieces are required to complete a wall corner.



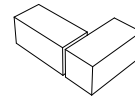

FULL-BED VENEER FLATS AND CORNERS²



Height	Depth	Length
3 5/8"	3 5/8"	23 5/8"
7 5/8"	3 5/8"	23 5/8"
11 5/8"	3 5/8"	23 5/8"
15 5/8"	3 5/8"	23 5/8"

² Granite: Full-bed veneer corners are sold separately. Limestone: Each piece of full-bed veneer can be used as a corner.

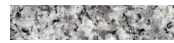
STONES

-  **INDIANA LIMESTONE - FULL COLOR BLEND™**
Limestone - Smooth
-  **CALEDONIA™**
Granite - Thermal (not available in thin veneer flats and corners)
-  **EASTERN GRAY™**
Granite - Thermal
-  **SAINT HENRY BLACK™**
Granite - Thermal (not available in thin veneer flats and corners)
-  **GEORGIA MARBLE™ PEARL GREY™**
Marble - Smooth

VANDERBILT CLASSIC™

PACKAGING INFORMATION

THIN VENEER FLAT							
Nominal size	True size	Thickness	Quantity per crate	Units per crate	Weight per crate (Lbs)		
					Limestone	Granite	Marble
4" x 24"	3 5/8" x 23 5/8"	Limestone 1 3/16" Granite 1" Marble 25/32"	Small crate 40 sq.ft.	60	650	545 - 760	492
			Large crate 160 sq.ft.	240	2,420	2,014 - 2,825	1,835
8" x 24"	7 5/8" x 23 5/8"	Limestone 1 3/16" Granite 1" Marble 25/32"	Small crate 40 sq.ft.	30	650	545 - 760	492
			Large crate 160 sq.ft.	120	2,420	2,014 - 2,825	1,835
12" x 24"	11 5/8" x 23 5/8"	Limestone 1 3/16" Granite 1" Marble 25/32"	Small crate 40 sq.ft.	20	650	545 - 760	492
			Large crate 160 sq.ft.	80	2,420	2,014 - 2,825	1,835
16" x 24"	15 5/8" x 23 5/8"	Limestone 1 3/16" Granite 1" Marble 25/32"	Small crate 40 sq.ft.	15	650	545 - 760	492
			Large crate 160 sq.ft.	60	2,420	2,014 - 2,825	1,835

CORNERS*							
4" x 24"	3 5/8" x 23 5/8"	Limestone 1 3/16" Granite 1" Marble 25/32"	Small crate 20 In.ft.	60	650	545 - 760	492
			Large crate 80 In.ft.	240	2,420	2,014 - 2,825	1,835
8" x 24"	7 5/8" x 23 5/8"	Limestone 1 3/16" Granite 1" Marble 25/32"	Small crate 20 In.ft.	30	650	545 - 760	492
			Large crate 80 In.ft.	120	2,420	2,014 - 2,825	1,835
12" x 24"	11 5/8" x 23 5/8"	Limestone 1 3/16" Granite 1" Marble 25/32"	Small crate 20 In.ft.	20	650	545 - 760	492
			Large crate 80 In.ft.	80	2,420	2,014 - 2,825	1,835
16" x 24"	15 5/8" x 23 5/8"	Limestone 1 3/16" Granite 1" Marble 25/32"	Small crate 20 In.ft.	15	650	545 - 760	492
			Large crate 80 In.ft.	60	2,420	2,014 - 2,825	1,835

FULL-BED VENEERS FLAT							
4" x 24"	3 5/8" x 23 5/8"	3 5/8"	80 sq.ft.	120	4,055	4,460 - 4,730	4,590
8" x 24"	7 5/8" x 23 5/8"	3 5/8"	80 sq.ft.	60	4,055	4,460 - 4,730	4,590
12" x 24"	11 5/8" x 23 5/8"	3 5/8"	80 sq.ft.	40	4,055	4,460 - 4,730	4,590
16" x 24"	15 5/8" x 23 5/8"	3 5/8"	80 sq.ft.	30	4,055	4,460 - 4,730	4,590

CORNERS							
4" x 24"	3 5/8" x 23 5/8"	3 5/8"	40 sq.ft.	60	N/A	2,230 - 2,365	N/A
8" x 24"	7 5/8" x 23 5/8"	3 5/8"	40 sq.ft.	30	N/A	2,230 - 2,365	N/A
12" x 24"	11 5/8" x 23 5/8"	3 5/8"	40 sq.ft.	20	N/A	2,230 - 2,365	N/A
16" x 24"	15 5/8" x 23 5/8"	3 5/8"	40 sq.ft.	15	N/A	2,230 - 2,365	N/A

*2 Quirk Miter Corner pieces are required to complete a wall corner.

SILLS

PRODUCT DATA SHEET



Scan me for more info.



INDIANA LIMESTONE - FULL COLOR BLEND™
Limestone - Sills

Sills add a subtle accent to any residential or commercial window project. Available in limestone, granite, or marble with a split-face or rock-face edge.

FULL SILLS

Depth	Height
6" x 48"	2 1/4"

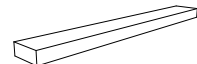



THIN SILLS

Depth	Height
3" x 48"	2 1/4"



STONES

-  **INDIANA LIMESTONE - FULL COLOR BLEND™**
Limestone - Rock-face
-  **EASTERN GRAY™**
Granite - Split-face
-  **GEORGIA MARBLE™ PEARL GREY™**
Marble - Split-face

DRIP EDGE NOT INCLUDED

DIAGRAM OF SILL INSTALLATION

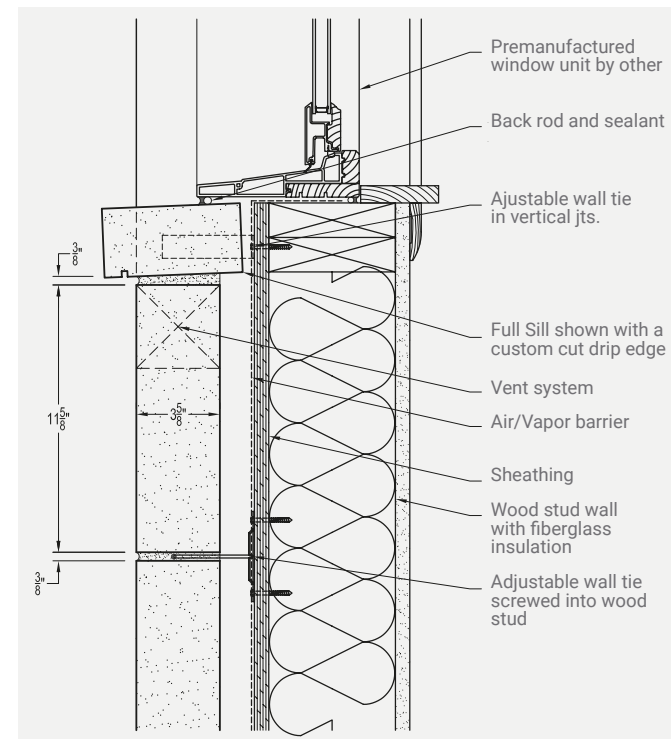

SILLS

PACKAGING INFORMATION

SILLS							
Products	Size	Depth	Quantity per crate	Units per crate	Weight per crate (Lbs)		
					Limestone	Granite	Marble
Full Sill - Split-face	2 1/4" x 48"	6"	144 ln.ft.	36	2,010	2,261	2,355
Thin Sill - Split-face	2 1/4" x 48"	3"	240 ln.ft.	60	1,631	1,889	1,968

ESTATE VENEER SERIES

INSTALLATION GUIDE



DISCLAIMER

This document is intended to be used as a reference for industry professionals who are competent to evaluate the significance and limitations of the information provided herein. This publication should not be used as the sole guide for adhered natural stone veneer and construction. Polycor disclaims any and all legal responsibility for the consequences of applying the information.

It is important to note that details and construction practices vary based on geographical requirements and practice. Design and construction must be adapted for each specific project and factor in regional judgment based on past experiences.

INTRODUCTION

Typically, products are installed by adhering directly to a properly designed and prepared support wall. Thin veneer is also referred to as adhered veneer by building codes and other industry documents.

Various methods, products, and materials are available; some are proprietary. Installation should comply with applicable building codes, manufacturer instructions, industry best practices, and project construction documents. Contact the thin veneer supplier or fabricator for further information regarding recommended installation methods and trained installers.

ESTATE VENEER SERIES

INSTALLATION GUIDE

CODES AND STANDARDS

MASONRY INDUSTRY CODES, STANDARDS, AND OTHER REFERENCES

This installation guide is written specifically to address adhered natural stone. Other documents to consult are:

- Applicable Building Code, e.g., International Building Code
- Applicable State or Local Municipal Codes, e.g, California has code modifications for thin veneers
- National Masonry Model Code, e.g., Building Code Requirements and Specification for Masonry Structures (TMS 402/602)
- ASTM C1242-15: Standard Guide for Selection, Design, and Installation of Dimension Stone Attachment Systems
- American National Standards Institute (ANSI) 118.4 - Modified Dry Set Cement Mortars
- Indiana Limestone Handbook - 22nd Edition - published by the Natural Stone Institute, or visit: naturalstoneinstitute.org
- International Masonry Institute

SYSTEMS OVERVIEW

THIN MASONRY VENEER SYSTEMS OVERVIEW

Thin masonry veneer systems offer masonry veneers that are thinner and lighter. There are many different types of adhered masonry veneer systems. Depending on the system used, these lightweight veneers can help reduce shipping and construction costs. Also, thin veneer stones can be applied without a stone ledge in the foundation wall. Natural thin stone products have proven to be more durable than manufactured thin stone products.

Thin masonry veneer systems can be installed as barrier or drainage walls. Properly designed drainage thin masonry veneer systems offer the advantages of increased drainage and drying capabilities. Barrier systems do not include adequate provisions for drainage and drying in many climates, so use of this wall type should be carefully considered. Consideration should be based on support wall type, moisture control layer type and location, climate, regional experience, level of installer training, and opportunities for inspection during installation.

WALL COMPONENTS

THIN MASONRY VENEER SYSTEM COMPONENTS

Durable exterior wall systems include an assembly of parts to control moisture, air movement, vapor diffusion, and energy. Depending on the application and regional modifications, below is a list of potential wall components for thin veneers:

- Support Wall
- Weep Screed
- Flashing

ESTATE VENEER SERIES

INSTALLATION GUIDE

- Weep Vents
- Casing Beads
- Water / Air / Vapor Barrier
- Drainage Mat
- Insulation

SUPPORT WALL

The success of thin veneers depends greatly on the proper design and preparation of the support wall. Polycor natural stone can be installed over:

- Poured-in-place concrete
- Precast concrete and tilt-up wall panels
- Concrete masonry units
- Framed wood or metal stud wall with sheathing
- Cement board sheathing

Do not install Polycor natural stone over any deteriorating, unsound surface or existing finish experiencing moisture-related issues. The following substrates are typically not good applications for adhered veneers:

- Existing siding in unsound condition
- EIFS
- Clay brick
- Surface below water level

POURED-IN-PLACE CONCRETE, PRECAST, AND TILT-UP WALL PANELS

- New concrete should be properly cured to accept thin veneer setting material
- Check for and remove contaminants such as dirt, dust, stains, paint, organic matter, form-release agents, or other substances that could inhibit mortar bond
- Surfaces with a Concrete Surface Profile (CSP) equal to or greater than 2 are usually acceptable for the installation of thin masonry veneers
- Make sure the wall is sound and without defects
- Check for plumb, level, and low or high points - modify setting method and material accordingly
- Poured-in-place concrete walls may have to be made level before using thin-set applications
- Provide capillary break between poured-in-place concrete, precast, and tilt-up wall panels and limestone veneer units to eliminate prolonged contact with alkali sources

CONCRETE MASONRY UNITS (CMU)

- New masonry should be properly cured to accept thin veneer setting material
- Check for and remove contaminants such as dirt, dust, stains, paint, organic matter, form-release agents, or other substances that could inhibit mortar bond
- Make sure the wall is sound and without defects
- Provide capillary break between concrete masonry units and limestone, granite, and marble veneer units to eliminate prolonged contact with alkali sources

ESTATE VENEER SERIES

INSTALLATION GUIDE

FRAMED WOOD OR METAL STUD WALLS WITH SHEATHING

- Per ASTM C1242-15, exterior walls to receive thin natural stone veneers should be designed with a stiffness ratio of L/1000 minimum
- CMU walls typically have stiffness ratios much greater than L/1000
- Thin natural stone veneer systems have been successful on substrates with stiffness ratios of L/600. Use regional judgment
- Single-story metal studs to be a minimum of 20-gauge spaced 16 inches on center
- Properly protected sheathing can be OSB, plywood, tile backer wall board, or cement board
- Do not install Polycor natural stone adhered veneers over open stud systems
- Install sheathing with recommended gaps between sheets and movement joints, per the sheathing manufacturer's instructions

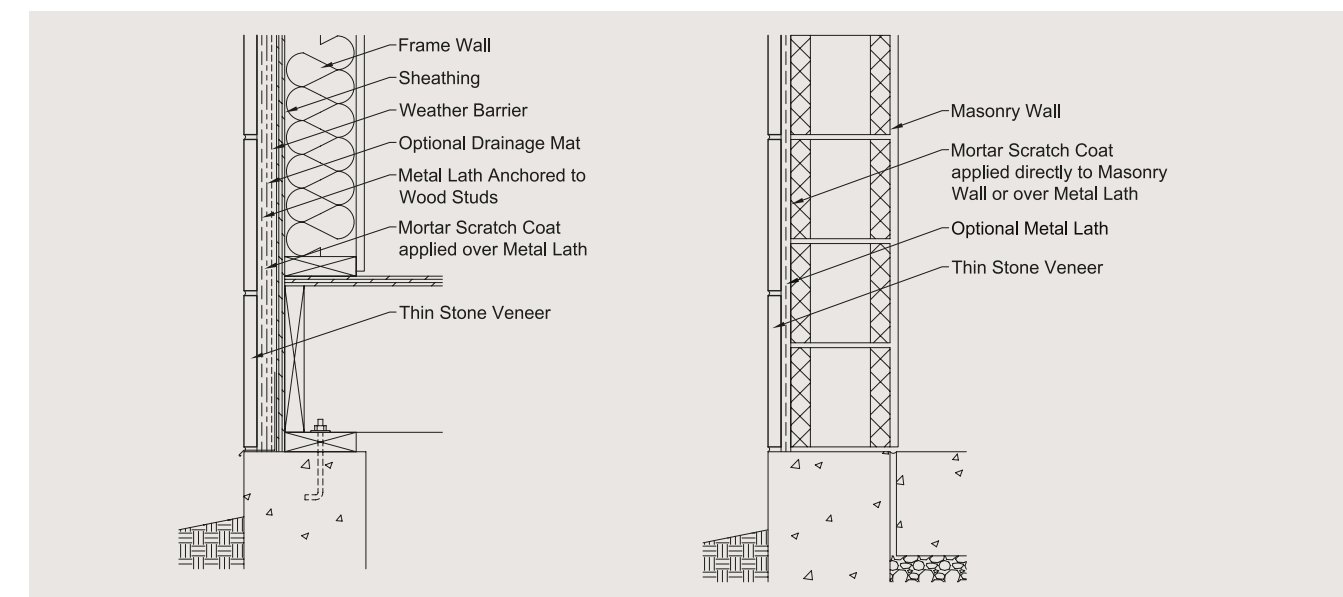

ESTATE VENEER SERIES

INSTALLATION GUIDE

CEMENT BOARD SHEATHING

- For exterior applications, use exterior-rated cement board
- For exterior applications, install cement board sheathing over primary wall sheathing to comply with structural, fire code, and wind code requirements
- For both exterior and interior cement board sheathing, install recommended movement joints, per the sheathing manufacturer's instructions
- Properly prepare joints between sheathing boards according the sheathing manufacturer's instructions
- Dampen cement board before applying the scratch coat

INTERIOR USES

- Design interior wall stiffness to L/600 minimum
- Polycor natural stone can be directly applied to interior tile backer wallboard or cement board
- Do not install adhered veneer units directly to wood substrates
- Dry-stack applications are acceptable for interior applications
- Movement joints in adhered veneer should align with points of expected movement in the support wall

WEEP SCREEDS, FLASHING AND WEEP VENTS

- Install code-approved water/air/vapor barrier in the proper location(s) within the wall assembly to control condensation and other moisture before the thin veneer is applied
- Use stainless steel or other non-staining weep screeds and flashing
- When using adhesive flashing membranes, use metal drip edge and hold flashing back from the veneer face by 1/2-inch or 3/4-inch to prevent flashing drool from coming out of the wall
- Secure weep screed and flashing to support wall to make it watertight
- Install flashing or other water-resistant material at top of the thin veneer to ensure water does not enter the veneer system from above, especially at the top locations where a different veneer material is installed above the thin masonry veneer
- Install weep vents 24 inches on the center. If using rope wicks, install them 16 inches on the center
- Install roof kickout flashing to keep rooftop rainwater from flowing onto veneer units

CASING BEADS

- Casing beads must be corrosion-resistant
- Casing beads can be used to cover the otherwise exposed scratch coat and setting bed at edges of wall panels
- Casing beads can be used to define movement joints in the scratch coat and setting bed. Refer to Technical Services Information Bureau Technical Bulletin 60.155

WATER/AIR/VAPOR BARRIER

- Install code-approved water/air/vapor barrier in the proper location(s) within the wall assembly to control condensation and other moisture before the thin veneer is applied
- Connect appropriate barriers to be air and water tight at openings and penetrations such as windows, doors, louvers, electrical boxes, conduits, and water-tight
- Install fluid-applied and sheet membrane barriers over moisture-sensitive support walls such as wood sheathing
- Install a minimum of two layers of building paper or building wrap water-resistive barriers under thin

ESTATE VENEER SERIES

INSTALLATION GUIDE

- veneer systems on non-moisture sensitive support walls
- Lap water-resistive barrier a minimum of 2 inches horizontally (shingle-style) and a minimum of 6 inches vertically or per manufacturer's instructions
- One layer of water-resistive barrier can be used behind a drainage mat, continuous insulation, or paper-backed lath

DRAINAGE MAT

- Install required drainage mats or furring strips per local building code
- Install drainage mats or furring strips behind thin veneers installed over wood support walls
- Drainage mats should have filter fabric or other means to keep scratch-coat mortar from interrupting the downward flow of moisture
- Use rigid drainage mats to provide rapid drying capacity to the wall and not to allow self-furring dimpled metal lath to sink into them
- Drainage mats must be a minimum of 3/16-inch and a maximum of 3/4-inch in thickness
- As required by the 2005 National Building Code of Canada, drainage mats must be 3/8-inch (10mm) in thickness

CONTINUOUS INSULATION

- Install primary air/water/vapor barrier under exterior continuous rigid insulation, as required
- Install rigid sheathing over exterior continuous rigid insulation before installing adhered veneer
- Tape or foam seams between sheets of insulation to make watertight and for continuity of thermal resistance
- When continuous insulation is more than 1/2-inch thick, lath fasteners and spacing should be engineered to carry dead and live loads
- For insulation that is more than 1 1/2 inches thick, metal Z-furring channels are often used instead of screws or other fasteners
- Consider installing Z-furring channels perpendicular to metal studs to minimize thermal transfers

LATH

- For natural stone adhered veneers, use a minimum of 3.4 pound/square foot expanded metal galvanized diamond metal lath conforming to *ASTM C1063-15: Standard Specification for Installation of Lathing and Furring to Receive Interior and Exterior Portland Cement-Based Plaster*
- All lath and lath accessories must be corrosion-resistant
- Consider using stainless steel lath in coastal regions and other situations where durability, corrosion of the metal lath, and staining are a concern
- Non-metallic lath material should meet ASTM C1780-13 standards, and be approved by local building officials
- Lath should be self-furring or attached with self-furring fasteners to allow for at least a 1/4-inch coat of mortar behind the lath
- Install metal lath with "cups" facing up to help prevent mortar from sagging and to create a physical bond
- Correctly installed, metal lath will feel rough to the touch when swiping a hand down and smooth going up
- Lath at least 1 inch on all sides and ends
- The ends of adjoining lath pieces should be staggered
- Install lath tight against the support wall, so there is no spring effect
- Wrap the metal lath tightly around corners for at least 12 inches and fasten to a framing member

ESTATE VENEER SERIES

INSTALLATION GUIDE

LATH FASTENERS

- Use corrosion-resistant fasteners that conform to ASTM C1063
- Fasteners should penetrate the wood studs by at least 1 1/4 inches or metal studs by at least 3/8-inch
- Copper staples can be used with a wide crown
- To prevent the lath from pulling out, fasteners used to attach the lath to the substrate should have a minimum washer size of 7/16 inch
- Space fasteners at most 7 inches apart vertically and at most 16 inches apart horizontally
- When continuous exterior insulation is more than 1/2-inch thick, use engineer sheathing and lath fasteners spacing and type to carry dead and live loads
- Helpful fastener engineering documents include: *Foam Sheathing Coalition's "Guide to Attaching Exterior Wall Coverings Through Foam Sheathing" December 7, 2011, and Dr. J Technical Evaluation Report TER Number | 302-01, September 11, 2013*
- Be aware that some natural stone-adhered veneer systems are near or greater than 25 psf
- With adhered veneer systems weighing over 25 psf, use Z-furring channels to support the stone over continuous exterior insulation that is more than 1 1/2 inches thick
- Where applicable, install Z-furring channels perpendicular to wall framing to minimize thermal transfers

MORTAR

- Use polymer-modified, non-staining, sag-resistant Type S (ASTM C270) stone veneer mortar for both scratch coat and setting bed
- Use low-alkali cement mortar mixes or polymer compounds to minimize staining potential
- Polymer compounds such as epoxy can be used, per ASTM C1242-15, if compatible with stone and substrate and do not exhibit long-term creep or staining
- Match mortar color to stone or lighter to reduce the potential darkening effect on veneer units from mortar setting bed
- The use of "low efflorescence" ANSI 118.7 high-performance sanded grout between units will minimize staining potential

VENEER UNITS

- The national masonry model code (TMS 402/602) defines "prescriptive requirements" for adhered veneer unit size not to exceed 2 5/8 inches in specified thickness, 36 inches in any face dimension, 5 sq. ft. in total face area, and shall not weigh more than 15 psf
- If adhered veneer units do not conform to these prescriptive requirements, designers can use the "alternative design" approach as outlined in TMS 402, Section 6.3.1
- For prescriptive requirement designs, the average thickness of Polycor natural stone must not be more than 1 1/4 inches thick
- Polycor natural stone veneer units should be 3 sq. ft. or less face area if the support wall has a deflection ratio of less than L/1000
- **INDIANA LIMESTONE - FULL COLOR BLEND™** limestone units that are 3/4-inch thick are more prone to breakage during handling and staining issues as compared to thicker units
- Check veneer units for cracks, damage, consistent thickness, cleanliness, and excessive over-cut corner pieces. Over-cutting should not be more than 1/3 stone depth
- Clean the back surface of veneer units to be adhered to remove of all dirt, debris, loose stone, or sediment before applying

ESTATE VENEER SERIES

INSTALLATION GUIDE

VENEER JOINTS

- For maximum weather resistance in mild to severe climates, use 3/8-inch concave mortar joints
- Rough-cut flush, raked, or stack bond joints will not be as water-resistant as tooled joints
- Raked or weathered joints should be compressed as firmly as possible when mortar is "thumbprint hard"
- To minimize shrinkage cracks in the joint, it is recommended to keep the mortar joints at a maximum width of 1/2 inch
- Pointing mortar can be used to achieve different colors
- Use professional and regional judgment when using dry-stack stone patterns. The Rocky Mountain Masonry Institute states: "Dry-stack patterns are not recommended for exterior use in harsh environments like Colorado."
- When using dry-stack patterns, consider using Thinset (ANSI 118.4) medium-grade or high-grade depending on exposure
- Indiana Limestone Institute recommends using type N mortar in veneer joints (ASTM C270)

MOVEMENT JOINTS

- According to the national masonry model code (TMS 402/602), the responsibility of locating movement joints lies with the building designer, not the mason
- Align both vertical and horizontal veneer movement joints with expected movement locations in the support wall
- Discontinue lath, scratch coat, and setting bed at movement joints
- Movement joints must be at least 3/8-inch wide
- ASTM C1242-15 recommends vertical movement joints to be spaced a maximum of 15 feet from the center
- The Building Stone Institute recommends vertical movement joints to be spaced a maximum of 30 feet from the center in walls without windows
- Add distance between vertical movement joints around outside corners
- Consider locating veneer movement joints at all inside corners
- For interior applications, align veneer movement joints with expected points of movement in the support wall
- Install 3/8-inch movement joints at the interface of stone veneer to window/door frames, other penetrations, and dissimilar veneer materials for installation of a backer rod and sealant
- When locating a movement joint by an opening near a corner, locate it on the corner side of the opening
- Locate horizontal movement joints to accommodate vertical movement of the building structure. This is especially important with wood substrates
- Decrease movement joint spacing in veneer with support walls less stiff than L/1000
- Movement joint sealant should be non-staining
- For additional information about the use of sealants and damp-proofing with **INDIANA LIMESTONE - FULL COLOR BLEND™** limestone, refer to the Indiana Limestone Handbook, published by the Indiana Limestone Institute of America
- Use professional and regional judgment when locating movement joints

WATER REPELLENT

- In general, water repellents are not required for Polycor natural stone veneers
- When using water repellents, use highly vapor-permeable penetrating clear liquids of low viscosity

ESTATE VENEER SERIES

INSTALLATION GUIDE

- For areas in need of protection due to expected graffiti, consult stone sealant manufacturers for a recommendation. Graffiti repellents sit atop the stone and may change the appearance of the stone
- For additional information regarding water repellents, refer to the Indiana Limestone Handbook, published by the Indiana Limestone Institute of America, or the Natural Stone Institute's (NSI) Dimension Stone Design Manual

INSTALLATION

SCRATCH COAT

Two acceptable methods of scratch coat installation are using the traditional hardened scratch coat or the "Scratch and Go" method.

OPTION #1: TRADITIONAL SCRATCH COAT

- Completely encapsulate the lath with a layer of mortar that is 1/2-inch to 3/4-inch thick
- To add horizontal texture to the scratch coat, use a steel comb or a 1/8-inch notched trowel
- Allow the scratch coat to dry for 24 to 48 hours
- Dampen the scratch coat with potable water before installing units

OPTION #2: "SCRATCH AND GO"

- This technique is sometimes desirable for construction sequencing purposes
- Completely encapsulate the lath with a layer of mortar that is 1/2-inch to 3/4-inch thick
- Keep work area limited to 10 sq. ft. so mortar on the wall does not fully set before placing stones
- Back butter and install veneer units. See the next section of this guide, Setting of Veneer Units
- Use shims to keep the stones from sagging

SETTING OF VENEER UNITS

- Dampen dried scratch coat or cement board sheathing with potable water before applying veneer units. The surface should be moist but not saturated
- In hot weather conditions or with hot units, dampen the back of the stone
- Apply a mortar bed that is at least 1/2 inch thick to the back. ASTM C1242-15 (~100%)
- Place a slight excess of mortar at the edges of the stone to allow some mortar to squeeze out of the stone edges and fill the joints when pressure is applied
- Place the stone firmly into the scratch coat with a slight rotating motion
- If the unit gets disturbed during installation, remove the unit and reset it with new mortar
- Do not install veneer units when other trades will be working nearby, resulting in vibration for 24 hours, e.g., site work or interior work
- The mortar behind the stones should then be at least 3/4-inch to 1 1/4 inches thick

CLEANING

- Keep stone veneer units clean during installation to ease final cleaning
- Installing veneer units from the top down helps keep units clean during construction
- Once the mortar droppings on the face of the stone have dried, they can be picked off or carefully brushed so that they do not smear
- Use clean, potable water for cleaning

ESTATE VENEER SERIES

INSTALLATION GUIDE

- Pre-wet veneer first before applying cleaning solutions
- Use mild soap powder, detergent, or a mild water and vinegar solution with a soft bristle brush to remove any dirt or mortar smears
- Do not use cleaning acids
- Do not use high-pressure cleaning methods unless approved
- Test cleaning solutions and procedures on a mock-up panel or sample panel on the building
- Keep Estate Veneer Series products protected from rundown from cleaning different veneer systems above
- "New Building Bloom" may appear on the veneer soon after construction, caused mainly by water in fresh mortar. This phenomenon is common and typically goes away in the first year of occupancy
- For help with difficult or chronic cleaning issues, contact the stone supplier

WORKMANSHIP

- Store materials off the ground and keep them covered to reduce exposure to rain, snow, groundwater, and mud splatters
- Cover adjacent grade to avoid stains from splashing water or mud. Keep protection in place until final landscaping is in place
- Cover tops of unfinished walls with water-resistant material during inclement weather and at the end of each workday
- Use clean, potable water for mortar, grout, wetting of substrate, veneer units, and cleaning
- Protect adjacent surfaces near the veneer installation area from potential damage, such as windows, doors, other cladding materials, and wood floors
- Minimize material handling on-site to reduce veneer unit chipping and breakage
- Turn up scaffolding boards near the wall at night to prevent rain from splashing onto veneer
- Keep stone veneer units clean during installation to ease final cleaning
- Once the mortar droppings on the face of the stone have dried, they can be picked off or carefully brushed so that they do not smear

HOT AND COLD WEATHER CONSTRUCTION

- Install scratch coat and veneer units according to hot and cold weather provisions as cited in the national masonry model code (TMS 602-11, Section 1.8D)
- In hot and dry climates and conditions, it is imperative to dampen the substrate and back of veneer units so moisture is not absorbed too quickly from mortar, resulting in improperly hydrated mortar and a weakened bond
- Providing shade or frequent misting of the wall may be required for proper curing of mortar

TESTING

- When fully cured, veneer units should be bonded to the wall with at least 50 psi minimum shear strength based on the gross unit surface when tested following ASTM C1780 and test method ASTM C482, or shall be adhered in compliance with Article 3.3C of the National Masonry Model Code (TMS 402/602)
- Additional periodic testing of veneer units during installation per ASTM C1242-15
- What will require observation? This sentence is unclear. Please advise
- See Section Overhead, Horizontal, and Tilting-Forward Applications of this guide

ESTATE VENEER SERIES

INSTALLATION GUIDE

MAINTENANCE

- Keep excessive moisture from saturating the wall
- Adjust landscape sprinklers, gutters and downspouts, roof kickout flashing, scuppers, etc., to prevent water from constantly wetting the wall
- Adjust landscaping to prevent dirt from splashing onto the wall
- Periodically remove organic matter such as ivy, moss, and mildew
- Ivy should be cut at the base, allowed to dry, and then brushed off
- Do not pull ivy suckers out of the stone
- Inspect cladding hands-on approximately one year after installation to verify performance
- Periodically inspect veneer for cracked/loose units or cracked mortar joints that may appear from building shifts and settlement. ASTM C1496 offers a guide to inspection
- Repoint mortar joint cracks and replace cracked or loose units to restore the wall's natural weather resistance and durability
- Do not subject **INDIANA LIMESTONE - FULL COLOR BLEND™** limestone or **GEORGIA MARBLE™ PEARL GREY™** marble to contact with de-icing materials or other harsh chemicals. Do not use de-icing chemicals on the area immediately adjacent to an **INDIANA LIMESTONE - FULL COLOR BLEND™** limestone or **GEORGIA MARBLE™ PEARL GREY™** marble veneer. Prolonged exposure to these conditions may discolor or damage the surface

DESIGN CONSIDERATIONS

BASE OF WALL

- Ensure that there is a 1/2-inch clearance above the walking
- Ensure that there is a 2 inch clearance above
- Ensure that there is a 6 inch clearance above the earth
- If you plan on using de-icing salts and solutions in an area where veneer units are installed, it is recommended to apply a breathable, penetrating water repellent to the face of the units 24 inches above the surface. This will help protect the stone from staining and deterioration. Additionally, it's important to protect the bottom edge of the veneer unit from absorbing moisture and contaminants. Alternatively, you can use one of Polycor's granite or marble options for base installation

WINDOW SILLS

- Window sills and courses protruding more than a 1/2 inch should be supported with corrosion-resistant clip angles at both ends of sill pieces to resist eccentric rotational forces
- Clip angle should support at least 2/3 of the depth of the sill or protruding stone
- Sills should have at least a 1 1/2 inch overhang
- It is recommended to have a drip cut on the underside of the sill unless the bottom edge is installed with a 5% pitch or greater
- Sills should be pitched away from the window
- Lug sills are more water-resistant than sills that stop at jamb
- Skyward-facing joints between sill pieces and at the end of sill pieces should be raked 3/4-inch deep for placement of the backer rod and caulk

ESTATE VENEER SERIES

INSTALLATION GUIDE

TOP OF WALL

- Create top-of-wall details to resist wind-driven moisture that may saturate the top of the stone, the setting bed, the scratch coat, or the support wall
- Consider installing a back rod and caulk between top of thin veneer and top of wall wood blocking before metal wall cap is installed
- Install through-wall sheet metal flashing under top of wall coping stones. Provide a 1 1/2 inch overhang on coping stone with drip cut on the underside. Rake joints between top-of-wall coping stones 3/4" deep for installation of back rod and caulk

OVERHEAD, HORIZONTAL, AND TILTING-FORWARD APPLICATIONS

- These applications should be approved by the local building official and visually inspected during installation, and sample units should be tested for bond strength
- Overhead, horizontal, and tilting-forward applications should use supplemental mechanical anchors

All Polycor Estate Veneer Series natural stone products meet or exceed the strength requirements set forth by ASTM standards, including that which is included in ASTM C568 for Type II Dimensional limestone for **INDIANA LIMESTONE - FULL COLOR BLEND™** limestone and in ASTM C615 for Dimensional granite, as well as ASTM C503 for Dimensional marble.

ABOUT POLYCOR

Polycor's natural stone products are the perfect choice for your architecture and landscape designs. With complete ownership of our supply chain and a broad range of marbles, granites, and limestones, Polycor can offer you shorter lead times and long-lasting results.

When it comes to premium materials, Polycor is the go-to source. Let us help you set the stage with stone.

ESTATE VENEER SERIES NEW

INSTALLATION GUIDE

ALTERNATIVE INSTALLATION METHOD #1

Alternative Mortars (Specialty Tube Products for Masonry)

New stone quarrying and manufacturing technologies have created a niche for natural stone thin veneers. Polycor's Estate Veneer Series offers thinner and lighter veneers, making them easier and faster to install than traditional full-bed veneers.

New adhesive technologies have unlocked fresh possibilities for veneer installation over substrates, including CMU block and Cement Backer Board, with options similar to, but not limited to, brands like Durock® and Permabase®*. The following installation methods employ specialty mortar alternative products engineered specifically for natural stone thin veneers.

(Please note that these alternative masonry products are specifically designed for shorter walls, including seating and retaining walls, outdoor kitchens, and feature walls. They are only suitable for constructing full-height walls that are at most 8 feet tall. For stone masonry projects involving higher walls, adhering to traditional methods that ensure full-mortar contact is essential. We recommend consulting your local building codes for detailed guidelines and compliance requirements.)

When installing over Durock® or Permabase®* cement backer boards, follow these steps: begin by installing backer boards according to the manufacturer's instructions. Tape all seams and corners of the cement board with 4-inch-wide alkali-resistant fiberglass mesh tape and embed it with an approved thin-set mortar (ensure that all mortars comply with ANSI 118.1, ANSI 118.4, and ANSI 118.15).

After the mortar has dried, apply a roll-on waterproofing membrane to the cement board, such as, but not limited to, MVIS™ Air & Water Barrier by Laticrete®*. Use a ½-inch nap roller to apply the membrane in two coats, allowing the first coat to dry before applying the second.

Once the membrane is dry to the touch, you can install the veneer.

The adhesive selected for this project is a specialized mortar alternative. It is important to know that these alternatives, designed for use with granite, marble, and limestone masonry, are not commonly found at large retail stores. However, you have the option to consider similar products, including but not limited to those offered by brands such as Vertical Instant Lock™ by SRW Products® and Stickystone™ by Techniseal®*.

These alternative mortars provide the benefit of instantly securing the stone veneer without any risk of it sagging or slipping. They cure quickly, are suitable for outdoor applications, and offer a window of up to 10 minutes for repositioning.

Before application, ensure that all surfaces are clear of any materials that may hinder adhesion, such as heavy textures, dirt, dust, or loose particles. Surfaces should be flat, completely dry, and maintained above 40°F (4°C).

ESTATE VENEER SERIES NEW

INSTALLATION GUIDE

Begin the veneer installation at the bottom corner of the wall. Attach a ledger board to the wall at grade. Select a corner veneer piece that complements your design to begin the first course of veneers.

Using an appropriately sized caulking gun with a minimum 14:1 thrust ratio, hold the nozzle at a 90° angle, with the v-notch up. Apply a series of continuous, vertical beads of adhesive to the veneer, spanning the entire width but staying a ½-inch away from the outside edge. Press the corner veneer into place.

For larger veneer pieces, you may need additional beads of adhesive. Avoid applying adhesive in a spot pattern and maintain a vertical alignment for the beads to facilitate water movement down the interior wall behind the veneer.

While working, periodically check the veneer to ensure it remains level and plumb.

Next, select veneer flats to create the desired pattern and repeat the process, working down the length of the wall. Remember to add appropriately sized spacers for all the joints to maintain a consistent and visually pleasing appearance.

If you're working with various veneer sizes, it can be helpful to lay out a series of veneer flats on the ground and experiment with different arrangements. Adjust as needed to create the most aesthetically pleasing design. Pattern selection is not an exact science; you should trust your eye and creativity. However, as a general rule, avoid continuous vertical joints that are taller than the longest veneer.

Check out our ESTATE VENEER SERIES COURSING DIAGRAM section for more information and coursing options.

When the wall is complete, mortar all the joints using an approved stone veneer mortar. We recommend using a colored Type N or Type S mortar. Polycor has had positive results with Spec Mix®* with certain applications. However, it's important to note that our experience may not necessarily apply to every project's unique requirements. Type N is the preferred choice for Indiana Limestone veneers as it has a lower psi strength. Using Type N mortar ensures that the joint will not exert excessive pressure on the stone, which could potentially cause damage. Both Type S or Type N is suitable options for granite and marble veneers.

Before starting the mortar work, ensure that all spacers are removed from the joints and carefully scrape out any adhesive that may have seeped into the joints. Place plastic sheets on any finished paving below or in other adjacent work areas to catch any excess mortar.

Next, mix the mortar with water using a paddle mixer attached to a drill in a 5-gallon bucket. Aim for a flowing consistency similar to smooth cake batter.

Prepare a grout bag by lightly spraying its interior with water and then fill it. Adjust the tip size as necessary to accommodate the ¾-inch joint. Twist the opposite end of the bag and begin squeezing the mortar into all the joints, starting from the bottom and working your way up.

ESTATE VENEER SERIES NEW

INSTALLATION GUIDE

Leave the joints slightly heavy with excess mortar, but be cautious not to apply so much that it runs down the face of the stone.

While working, use a damp rag and a bucket of water to clean the mortar from the stone surface. Do not use acid; instead, opt for cleaning agents that have been approved for this purpose. It's crucial to check with the manufacturer to select a product that is suitable for the type of stone you are working with. If you need to use a power washer, ensure that it operates at a maximum pressure of 1,200 psi and is held at a distance of 16 inches from the surface. Use a 45-degree fan nozzle for this task.

Once the mortar is slightly firm and has set (approximately 15 minutes), it's time to begin tooling the joints. Use a $\frac{3}{8}$ -inch masonry tuckpointing tool to press and rake the mortar into the joints, shaping them as you work. Start by tooling the vertical and head joints, then follow with long, continuous strokes along the length of the horizontal joints. Be diligent in wiping and cleaning the stone as needed to remove any excess mortar or drips resulting from the application process.

After the mortar has been tooled and has fully cured, use a nylon brush to sweep all the joints. This step helps eliminate any remaining excess mortar and further refines the appearance of the joints. Your veneer work is now complete.

Over CMU block applications: Please note that CMU block generally does not require the application of a water barrier when using this product, except when using Indiana Limestone veneers.

* Please be aware that the mention of these brands is for illustrative purposes only and does not imply an endorsement or warranty by Polycor for any specific product. Polycor does not assume liability for using these products and encourages customers to conduct their own research, seek professional advice from local suppliers, and exercise proper due diligence when selecting products that best suit their needs and project requirements.

ESTATE VENEER SERIES NEW

INSTALLATION GUIDE

ALTERNATIVE INSTALLATION METHOD #2

Adhered Veneer with Polymer Modified Mortar on CMU Wall

Adhered masonry veneers can greatly benefit from the use of polymer-fortified setting materials readily available at local building material supply centers. These products are similar, but not limited to, trusted brands like Masonry Veneer Installation System (MVIS™) by Laticrete®*.

Products like MVIS™* offer long-term performance for various masonry veneer projects. They meet and exceed the ASTM C270 compressive strength and ASTM C482 bond shear strength requirements for masonry veneer installations.

Start by establishing a level line and snap chalk lines corresponding to the coursing and finish heights of the veneer. Before attaching a ledger board to the wall for the starter course of veneer, ensure it is level. Double-check all measurements before you begin applying mortar.

Mix MVIS™ Veneer Mortar* with water to the desired consistency using a paddle mixer and a drill, following the manufacturer's recommendations (approximately 3.4 parts powder to 1 part water.) Mix for one minute or until you achieve a creamy, smooth, mashed potato consistency. Allow it to slake for 5 minutes, mix again, and then begin use. Add slightly more water if necessary to obtain the proper consistency.

Using the flat side of a $\frac{1}{2}$ -inch by $\frac{1}{2}$ -inch notched trowel, key a skim coat of mortar to the wall approximately $\frac{1}{2}$ -inch to $\frac{3}{4}$ -inch thick. Once applied, turn the trowel to the notched side, hold it at a 45-degree angle, and run grooves into the mortar. Apply only enough mortar that can be fully covered with the veneer within a 15–20-minute timeframe.

Begin by selecting your corner veneer pieces for installation at outside corners first.

Before installation, clean the back of the stone to remove any dust or excess film that could impede bonding. Next, back-butter the entire back side of the stone veneer with a thin skim coat of the mortar using a margin trowel.

Place the veneer in the intended location with a firm, even pressure, initially shifting it about 1 to 1 $\frac{1}{2}$ inches away from its final position. Then, slide it back into the desired position while maintaining even pressure. This method helps ensure that the mortar is fully embedded in the space between the veneer and the wall, squeezing out around the edges to indicate proper adhesion and complete coverage of the substrate and the stone. Once the veneer is in its final position, insert appropriately sized spacers into the joint to maintain equal joint width.

Check the MVIS™* mortar for complete coverage by periodically removing a piece of veneer and inspecting the transfer onto the back of the stone. Allow a maximum of 16 linear feet between control joints or per the architect's specifications during the installation.

Clean the excess, extruded mortar out of the joints with the trowel to allow space for pointing mortar.

ESTATE VENEER SERIES NEW

INSTALLATION GUIDE

Finally, check the MVIS™* mortar for complete coverage by periodically removing a piece of veneer and inspecting the transfer onto the back of the stone.

Work your way up along the wall and inwards from the corner pieces using proper spacers, depending on the stone style chosen, to maintain equal joint widths. If you're working with various veneer sizes, it can be helpful to lay out a series of veneer flats on the ground and experiment with different arrangements. Adjust as needed to create the most aesthetically pleasing design. Pattern selection is not an exact science; you should trust your eye and creativity. However, as a general rule, avoid continuous vertical joints that are taller than the tallest piece and horizontal joints that are longer than three consecutive pieces.

Check out our [ESTATE VENEER SERIES COURSING DIAGRAM](#) section for more information and coursing options.

The final step is to install the pointing mortar in the desired premixed color to complement the design. We recommend type N mortar. Polycor has had positive results with Spec Mix®* with certain applications. However, it's important to note that our experience may not necessarily apply to every project's unique requirements. Type N is the preferred choice for Indiana Limestone veneers as it has a lower psi strength. Using Type N mortar ensures that the joint will not exert excessive pressure on the stone, which could potentially cause damage. Both Type S or Type N is suitable options for granite and marble veneers.

Start by removing all the spacers from the joints in preparation for the mortar job. Place plastic sheets on any finished paving below or in other adjacent work areas to catch any excess mortar.

Next, mix the mortar with water using a paddle mixer attached to a drill in a 5-gallon bucket. Aim for a flowing consistency similar to smooth cake batter.

Prepare a grout bag by lightly spraying its interior with water and then fill it. Adjust the tip size as necessary to accommodate the joint size. Twist the opposite end of the bag and begin squeezing the mortar into all the joints, starting from the bottom and working your way up.

Leave the joints slightly heavy with excess mortar, but be cautious not to apply so much that it runs down the face of the stone.

While working, use a damp rag and a bucket of water to clean the mortar from the stone surface. Do not use acid; instead, opt for cleaning agents that have been approved for this purpose. It's crucial to check with the manufacturer to select a product that is suitable for the type of stone you are working with. If you need to use a power washer, ensure that it operates at a maximum pressure of 1,200 psi and is held at a distance of 16 inches from the surface. Use a 45-degree fan nozzle for this task.

Once the mortar is slightly firm and has set (approximately 15 minutes), it's time to begin tooling the joints. Use masonry tuckpointing tool to press and consolidate the mortar into the joints, shaping them as you work. Start by tooling the vertical and head joints, then follow with long, continuous strokes along

ESTATE VENEER SERIES NEW

INSTALLATION GUIDE

the length of the horizontal joints. Be diligent in wiping and cleaning the stone as needed to remove any excess mortar or drips resulting from the application process.

After the mortar has been tooled and has fully cured, use a nylon brush to sweep all the joints. This step helps eliminate any remaining excess mortar and further refines the appearance of the joints. Your veneer work is now complete.

Note: When installing Indiana Limestone veneers directly onto CMU, it is important to damp proof the block or the veneers with a cementitious damp-proofing product, similar to, but not limited to, trusted brands like MasterSeal® 581 by BASF.

* Please be aware that the mention of these brands is for illustrative purposes only and does not imply an endorsement or warranty by Polycor for any specific product. Polycor does not assume liability for using these products and encourages customers to conduct their own research, seek professional advice from local suppliers, and exercise proper due diligence when selecting products that best suit their needs and project requirements.

ESTATE VENEER SERIES **NEW**

INSTALLATION GUIDE

ALTERNATIVE INSTALLATION METHOD #3

Thin Stone Veneer over Wood-Framed Stud Wall

A wood stud wall system is made of plywood sheathing with a first layer of weather resistive barrier (similar, but not limited to, Henry® Blueskin® Air and Vapor Barrier*), followed by a layer of rainscreen (similar, but not limited to, Mortairvent® by Advanced Building Products*) for proper drainage, then covered with cement board and a final layer of liquid-applied WRB below the veneer.

To begin, evaluate the sheathing to ensure the surfaces are sound, dry, and clean for optimal adhesion of the vapor barrier. Products such as Henry® Blueskin®* are self-adhesive backed, vapor-permeable materials and water-resistive air barriers that don't require mechanical attachment. Begin at the bottom of the wall, peel back the film, and press firmly into place, working from the center outwards, removing wrinkles and air bubbles. Install in a shingle-style fashion, overlapping joints a minimum of 3 inches.

Next, apply rainscreen sheets to the wall and secure with staples, overlapping the joints.

Attach sheets of cement backer board (similar, but not limited to, Durock® or Permabase®*) to the wall on top of the rainscreen, staggering the end joints in successive courses and driving fasteners at maximum of 8 inches on center. Mud and tape the joints with 4 inches alkali-resistant fiberglass mesh tape and an approved thin-set mortar.

Next, apply a roll-on, liquid water/air resistive barrier (WRB) to the cement board per the manufacturer's instructions, ensuring full coverage. Polycor has had positive results with MVIS™ Air & Water Barrier by Laticrete® with certain applications. However, it's important to note that our experience may not necessarily apply to every project's unique requirement.

Finally, apply sealants to all the windows, doors, and adjoining materials.

Adhered masonry veneers can greatly benefit from using polymer-fortified setting materials readily available at local building material supply centers. These products are similar, but not limited to, trusted brands like Masonry Veneer Installation System (MVIS™) by Laticrete®*.

Products like MVIS™* offer long-term performance for various masonry veneer projects. They meet and exceed the ASTM C270 compressive strength and ASTM C482 bond shear strength requirements for masonry veneer installations.

Start by establishing a level line and snap chalk lines corresponding to the coursing and finish heights of the veneer wall. Determine where to begin the starter course of veneer based on these considerations and joint widths. Attach a ledger board to the wall, ensuring it is level for the starter course of veneer.

Before installation, clean the back of the stone to remove any dust or excess film that could impede bonding. Begin with the outside corner pieces, working inwards from the ends along the string lines and ledger boards.

ESTATE VENEER SERIES **NEW**

INSTALLATION GUIDE

Mix MVIS™ Veneer Mortar* with water to the desired consistency using a paddle mixer and a drill, following the manufacturer's recommendations (approximately 3.4 parts powder to 1 part water.) Mix for one minute or until you achieve a creamy, smooth, mashed potato consistency. Allow it to slake for 5 minutes, mix again, and then begin use. Add slightly more water if necessary to obtain the proper consistency.

Using the flat side of a ½-inch by ½-inch notched trowel, key a skim coat of mortar to the wall approximately ½-inch to ¾-inch thick. Once applied, turn the trowel to the notched side, hold it at a 45-degree angle, and run grooves into the mortar. Apply only enough mortar that can be covered with the veneer within a 15–20-minute timeframe.

Before installation, clean the back of the stone to remove any dust or excess film that could impede bonding. Next, back butter the entire back side of the stone veneer with a thin skim coat of the mortar using a margin trowel.

Place the veneer in the intended location with a firm, even pressure, initially shifting it about 1 to 1 ½ inches away from its final position. Then, slide it back into the desired position while maintaining even pressure. This method helps ensure that the mortar is fully embedded in the space between the veneer and the wall, squeezing out around the edges to indicate proper adhesion and complete coverage of the substrate and the stone.

Clean the excess extruded mortar with the trowel out of the joints to allow space for pointing mortar. Check the MVIS™* mortar for complete coverage by periodically removing a piece of veneer and inspecting the transfer onto the back of the stone. Allow a maximum of 16 linear feet between control joints or per the architect's specifications during the installation.

Work your way up along the wall and inwards from the corner pieces using proper spacers to maintain equal joint widths. If you're working with various veneer sizes, it can be helpful to lay out a series of veneer flats on the ground and experiment with different arrangements. Adjust as needed to create the most aesthetically pleasing design. Pattern selection is not an exact science; you should trust your eye and creativity. However, as a general rule, avoid continuous vertical joints that are taller than the tallest piece and horizontal joints that are longer than three consecutive pieces.

Check out our ESTATE VENEER SERIES COURSING DIAGRAM section for more information and coursing options.

When the wall is complete, it's time to use an approved stone veneer mortar to mortar all the joints. We recommend type N mortar for jointing, made from Portland cement, hydrated lime, and dried masonry sand. Polycor has had positive results with Spec Mix®* with certain applications. However, it's important to note that our experience may not necessarily apply to every project's unique requirements. Type N is the preferred choice for Indiana Limestone veneers as it has a lower psi strength. Using Type N mortar ensures that the joint will not exert excessive pressure on the stone, which could potentially cause damage. Both Type S or Type N is suitable options for granite and marble veneers.

ESTATE VENEER SERIES **NEW**

INSTALLATION GUIDE

Start by removing all spacers from the joints in preparation for the mortar job. Next, mix the mortar with water using a paddle mixer attached to a drill in a 5-gallon bucket. Aim for a flowing consistency similar to smooth cake batter.

Prepare a grout bag by lightly spraying its interior with water and then fill it. Adjust the tip size as necessary to accommodate the joint size. Twist the opposite end of the bag and begin squeezing the mortar into all the joints, starting from the bottom and working your way up.

Leave the joints slightly heavy with excess mortar, but be cautious not to apply so much that it runs down the face of the stone.

While working, use a damp rag and a bucket of water to clean the mortar from the stone surface. Do not use acid; instead, opt for cleaning agents that have been approved for this purpose. It's crucial to check with the manufacturer to select a product that is suitable for the type of stone you are working with. If you need to use a power washer, ensure that it operates at a maximum pressure of 1,200 psi and is held at a distance of 16 inches from the surface. Use a 45-degree fan nozzle for this task.

Once the mortar is slightly firm and has set (approximately 15 minutes), it's time to begin tooling the joints. Use a masonry tuckpointing tool to press and consolidate the mortar into the joints, shaping them as you work. Start by tooling the vertical and head joints, then follow with long, continuous strokes along the length of the horizontal joints. Be diligent in wiping and cleaning the stone as needed to remove any excess mortar or drips resulting from the application process.

After the mortar has been tooled and has fully cured, use a nylon brush to sweep all the joints. This step helps eliminate any remaining excess mortar and further refines the appearance of the joints. Your veneer work is now complete.

* Please be aware that the mention of these brands is for illustrative purposes only and does not imply an endorsement or warranty by Polycor for any specific product. Polycor does not assume liability for using these products and encourages customers to conduct their own research, seek professional advice from local suppliers, and exercise proper due diligence when selecting products that best suits their needs and project requirements.

ESTATE VENEER SERIES

COURSING DIAGRAM



Polycor provides timeless accents and durability to your residential or commercial project. Our natural stone veneers offer the perfect complement to your design vision and are available in three styles. We have a distinguished history, large inventory, and superior turnaround time. As a result, we are able to guarantee consistent veneers to fit your design needs.

COMMON APPLICATIONS

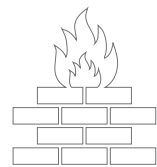

HEARTH & MANTEL

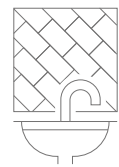

KITCHEN & BATH

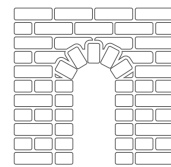

EXTERIOR FACADES

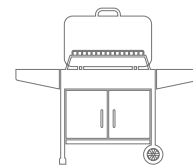

OUTDOOR LIVING

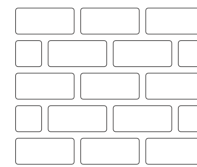

COLUMNS

COURSING OPTIONS

Ensure the perfect blend of stone for your project by mixing and matching veneers. These coursing styles can be accomplished with both thin and full-bed veneers. A mix of patterns shows creativity and depth, unique to your personal style.

ROCKFORD ESTATE BLEND™

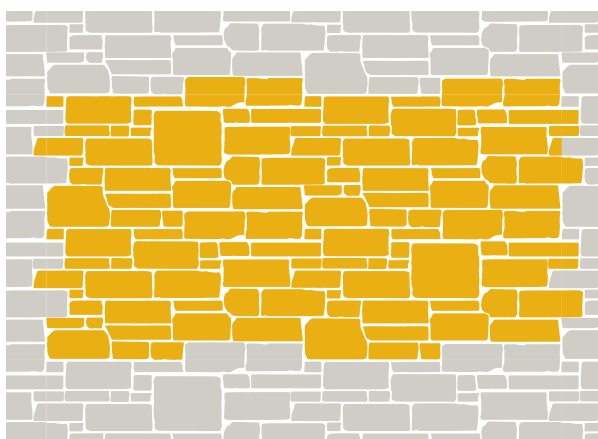

Module	Size (in)
-	2-12 (H) x variable

ESTATE VENEER SERIES

COURSING DIAGRAM



VANDERBILT CLASSIC™ - RUNNING BOND (4 x 24)

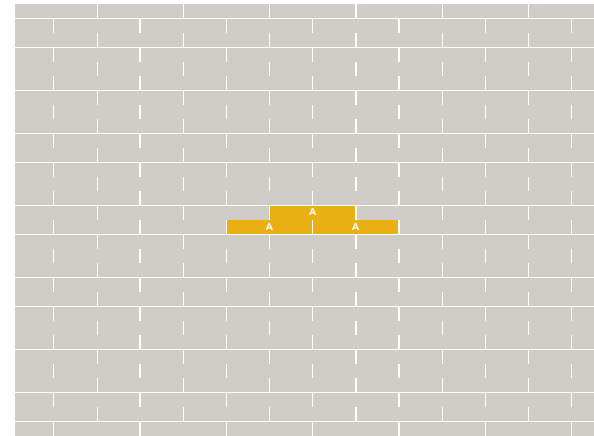

Module	Size (in)
A	3 5/8 (H) x 23 5/8 (L)

VANDERBILT CLASSIC™ - RUNNING BOND (8 x 24)

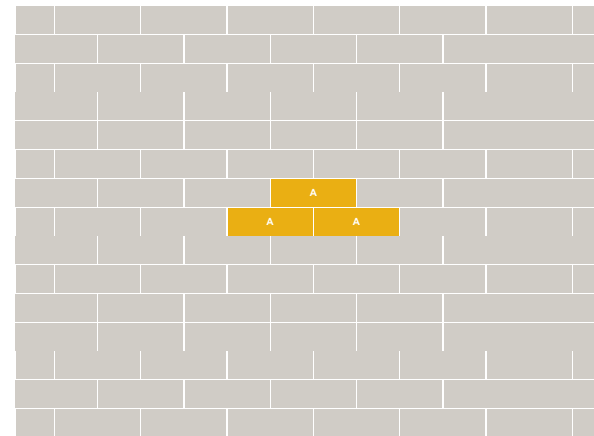

Module	Size (in)
A	7 5/8 (H) x 23 5/8 (L)

VANDERBILT CLASSIC™ - RUNNING BOND (12 x 24)

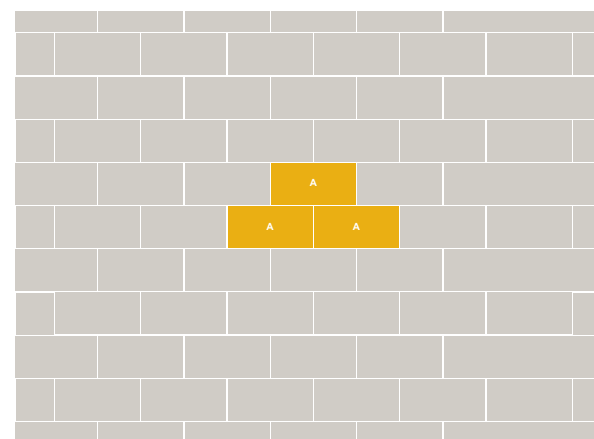

Module	Size (in)
A	11 5/8 (H) x 23 5/8 (L)

ESTATE VENEER SERIES

COURSING DIAGRAM



VANDERBILT CLASSIC™ - RUNNING BOND (16 x 24)

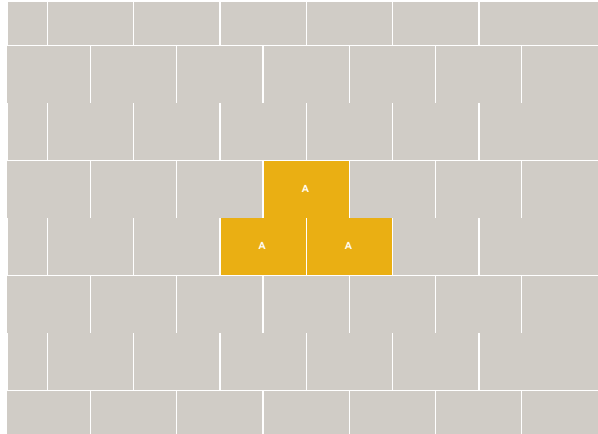

Module	Size (in)
A	15 5/8 (H) x 23 5/8 (L)

VANDERBILT CLASSIC™ - 3 COURSE RUNNING BOND

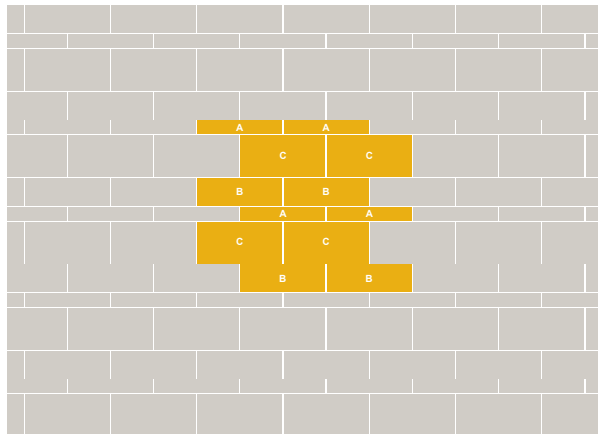

Module	Size (in)	Coverage
A	3 5/8 (H) x 23 5/8 (L)	17%
B	7 5/8 (H) x 23 5/8 (L)	33%
C	11 5/8 (H) x 23 5/8 (L)	50%

BERKSHIRE™ - 4 HEIGHT ASHLAR

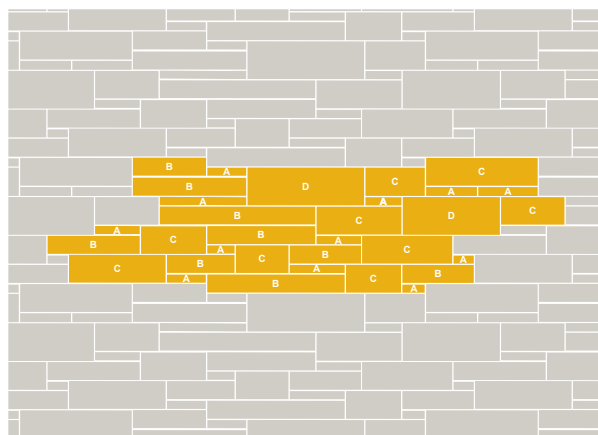

Module	Size (in)	Coverage
A	2 1/4 (H) x variable	10%
B	5 (H) x variable	35%
C	7 3/4 (H) x variable	40%
D	10 1/2 (H) x variable	15%

ESTATE VENEER SERIES

COURSING DIAGRAM



BERKSHIRE™ - 3 HEIGHT ASHLAR

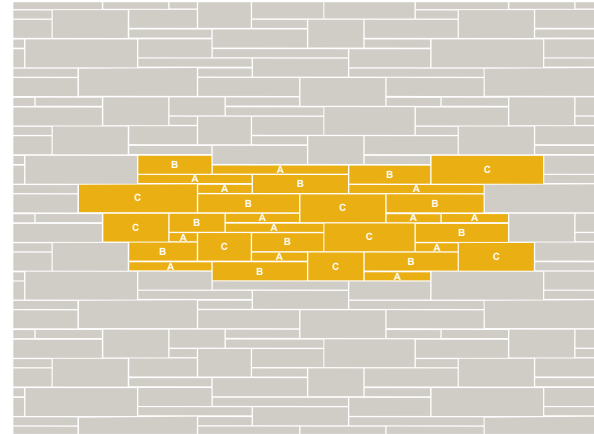

Module	Size (in)	Coverage
A	2 1/4 (H) x variable	15%
B	5 (H) x variable	40%
C	7 3/4 (H) x variable	45%

BERKSHIRE™ - 4 HEIGHT LINEAR

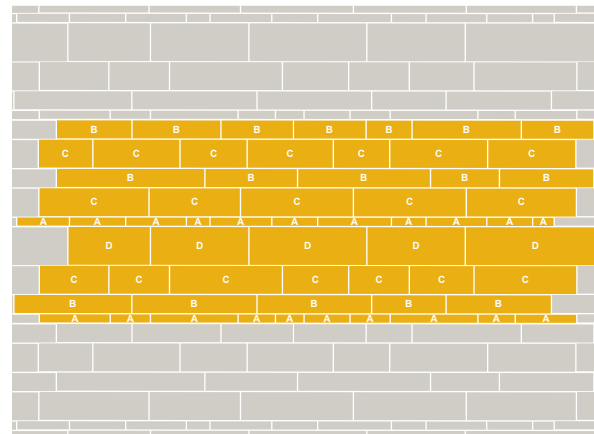

Module	Size (in)	Coverage
A	2 1/4 (H) x variable	10%
B	5 (H) x variable	35%
C	7 3/4 (H) x variable	40%
D	10 1/2 (H) x variable	15%

BERKSHIRE™ - 3 HEIGHT LINEAR

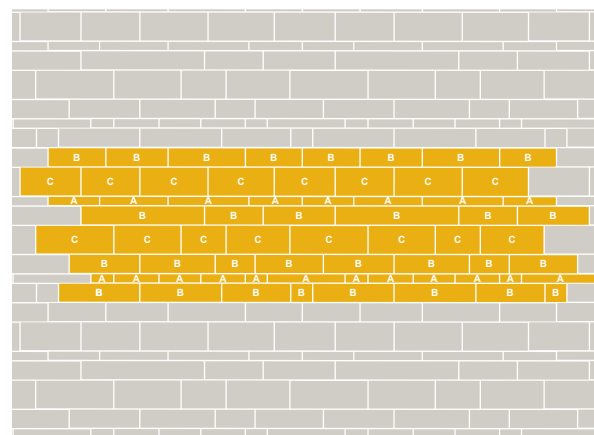

Module	Size (in)	Coverage
A	2 1/4 (H) x variable	15%
B	5 (H) x variable	40%
C	7 3/4 (H) x variable	45%

WALKWAYS & PATIOS

Take your project to the next level.

From the organic look of winding walkways to the clean lines of formal patios and poolscapes, natural stone sets the stage for outdoor living designs.

Pavers NEW	56
XL Pavers NEW	58
Pattern Pavers NEW	60
Pavers Installation Guide NEW	69
Pool Coping NEW	72



XL PAVERS

PRODUCT DATA SHEET



Scan me for more info.



SAINT HENRY BLACK™
Granite - XL pavers and pool coping

Available in two different sizes, our XL pavers are the perfect solution to enhance entrances, walkways, and patios. Providing straight, clean lines for a contemporary look, large pavers have a unifying effect, making any space feel larger.

Shape	Nominal Size	True Size	Thickness
	24" x 48"	23 5/8" x 47 5/8"	1 1/4" or 3/4"
	36" x 36"	35 5/8" x 35 5/8"	1 1/4" or 3/4"

STONES

- INDIANA LIMESTONE - FULL COLOR BLEND™***
Limestone - Smooth, Antique, Bush-hammered, Sandblasted (Only available in 1 1/4" thickness)
- CALEDONIA™**
Granite - Thermal, Smooth, Antique, Sandblasted, or Waterjet
- EASTERN GRAY™**
Granite - Thermal, Smooth, or Waterjet
- KODIAK BROWN™** NEW
Granite - Thermal, Smooth, Antique, Sandblasted, or Waterjet
- PICASSO™** NEW
Granite - Thermal, Smooth, Antique, Sandblasted, or Waterjet
- SAINT HENRY BLACK™**
Granite - Thermal, Smooth, Antique, Sandblasted, or Waterjet
- GEORGIA MARBLE™ PEARL GREY™**
Marble - Sandblasted, Smooth, or Antique
- GEORGIA MARBLE™ WHITE CHEROKEE™** NEW
Marble - Sandblasted, Smooth, or Antique

*Note: Cement-based damp-proofing should be applied to the back and all unexposed sides of the pavers to protect the limestone from moisture and prevent staining.

XL PAVERS

PACKAGING INFORMATION

1 1/4" XL PAVER							
Nominal Size	True Size	Thickness	Quantity per crate	Units per crate	Weight per crate (Lbs)		
					Limestone	Granite	Marble
24" x 48"	23 5/8" x 47 5/8"	1 1/4"	96 sq.ft.	12	1,457	1,650 - 1788	1,705
36" x 36"	35 5/8" x 35 5/8"	1 1/4"	108 sq.ft.	12	1,637	1,855 - 2010	1,917

3/4" XL PAVER							
Nominal Size	True Size	Thickness	Quantity per crate	Units per crate	Weight per crate (Lbs)		
					Limestone	Granite	Marble
24" x 48"	23 5/8" x 47 5/8"	3/4"	96 sq.ft.	12	894	1,010 - 1,093	1,043
36" x 36"	35 5/8" x 35 5/8"	3/4"	108 sq.ft.	12	1,002	1,133 - 1,226	1,170

PATTERN PAVERS

PRODUCT DATA SHEET



Scan me for more info.

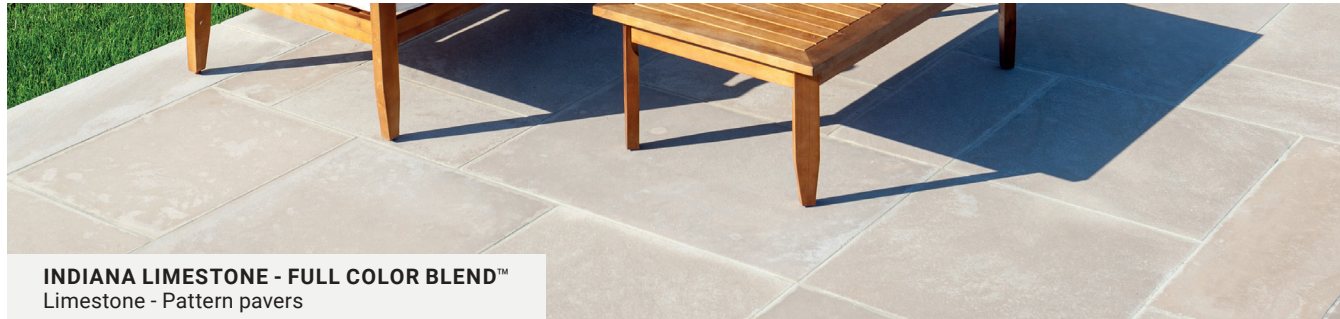

INDIANA LIMESTONE - FULL COLOR BLEND™
Limestone - Pattern pavers

Sold in sets with three different sizes, pattern pavers provide contractors with a wide array of design options. Simplify your design with pre-configured layouts.

PRE-PACKAGED 3-PIECE

Dimensions*	Thickness
12" x 24"	1 1/4" or 3/4"
24" x 24"	1 1/4" or 3/4"
24" x 36"	1 1/4" or 3/4"

*All pavers are nominal cut (e.g. 12" x 24" is actually 11 5/8" x 23 5/8", etc.)
Ratio: 17% - 12" x 24", 33% - 24" x 24", 50% - 24" x 36".



PRE-PACKAGED 4-PIECE



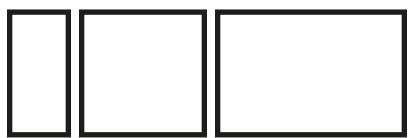

Dimensions*	Thickness
12" x 12"	1 1/4" or 3/4"
12" x 24"	1 1/4" or 3/4"
24" x 24"	1 1/4" or 3/4"
24" x 36"	1 1/4" or 3/4"

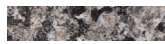
*All pavers are nominal cut (e.g. 12" x 24" is actually 11 5/8" x 23 5/8", etc.)
Ratio: 11% - 12" x 12", 11% - 12" x 24", 44% - 24" x 24", 33% - 24" x 36".

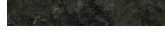

STONES

-  **INDIANA LIMESTONE - FULL COLOR BLEND™***
Limestone - Smooth, Antique, Bush-hammered, or Sandblasted
-  **CALEDONIA™**
Granite - Thermal, Smooth, Antique, Sandblasted, or Waterjet
-  **EASTERN GRAY™**
Granite - Thermal, Smooth, or Waterjet
-  **KODIAK BROWN™ NEW**
Granite - Thermal, Smooth, Antique, Sandblasted, or Waterjet

-  **PICASSO™ NEW**
Granite - Thermal, Smooth, Antique, Sandblasted, or Waterjet
-  **SAINT HENRY BLACK™**
Granite - Thermal, Smooth, Antique, Sandblasted, or Waterjet
-  **GEORGIA MARBLE™ PEARL GREY™**
Marble - Sandblasted, Smooth, or Antique
-  **GEORGIA MARBLE™ WHITE CHEROKEE™ NEW**
Marble - Sandblasted, Smooth, or Antique

*Note: Cement-based damp-proofing should be applied to the back and all unexposed sides of the pavers to protect the limestone from moisture and prevent staining.

PATTERN PAVERS

PACKAGING INFORMATION

1 1/4" PATTERN PAVER							
Products	Size	Thickness	Quantity per crate	Units per crate	Weight per crate (Lbs)		
					Limestone	Granite	Marble
Pre-packaged 3-height 12" x 24" 24" x 24" 24" x 36"	17% 11 5/8" x 23 5/8" 33% 23 5/8" x 23 5/8" 50% 23 5/8" x 35 5/8"	1 1/4"	144 sq.ft.	36	2,144	2,431 - 2,636	2,513
Pre-packaged 4-height 12" x 12" 12" x 24" 24" x 24" 24" x 36"	11% 11 5/8" x 11 5/8" 11% 11 5/8" x 23 5/8" 45% 23 5/8" x 23 5/8" 33% 23 5/8" x 35 5/8"	1 1/4"	108 sq.ft.	36	1,615	1,830 - 1,983	1,891

3/4" PATTERN PAVER							
Products	Size	Thickness	Quantity per crate	Units per crate	Weight per crate (Lbs)		
					Limestone	Granite	Marble
Pre-packaged 3-height 12" x 24" 24" x 24" 24" x 36"	17% 11 5/8" x 23 5/8" 33% 23 5/8" x 23 5/8" 50% 23 5/8" x 35 5/8"	3/4"	144 sq.ft.	36	1,306	1,479 - 1,602	1,528
Pre-packaged 4-height 12" x 12" 12" x 24" 24" x 24" 24" x 36"	11% 11 5/8" x 11 5/8" 11% 11 5/8" x 23 5/8" 45% 23 5/8" x 23 5/8" 33% 23 5/8" x 35 5/8"	3/4"	108 sq.ft.	36	989	1,118 - 1,210	1,125

PAVER LAYOUT DESIGNS



BILTMORE (PRE-PACKAGED 4-PIECE)

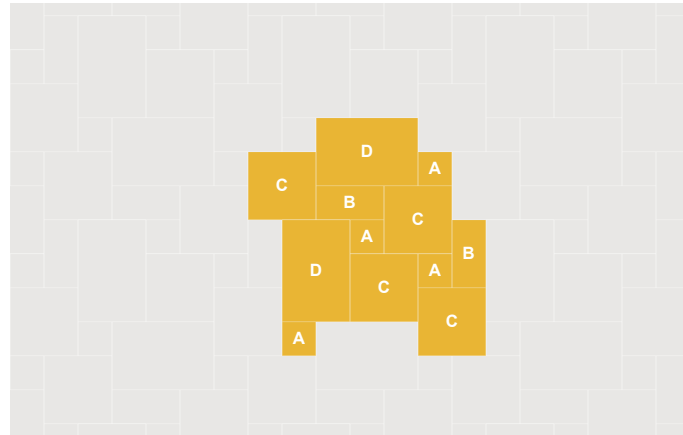

Module	Size (in)	Pcs required	Coverage
A	12 x 12	4	11%
B	12 x 24	2	11%
C	24 x 24	4	45%
D	24 x 36	2	33%

CAMBRIDGE

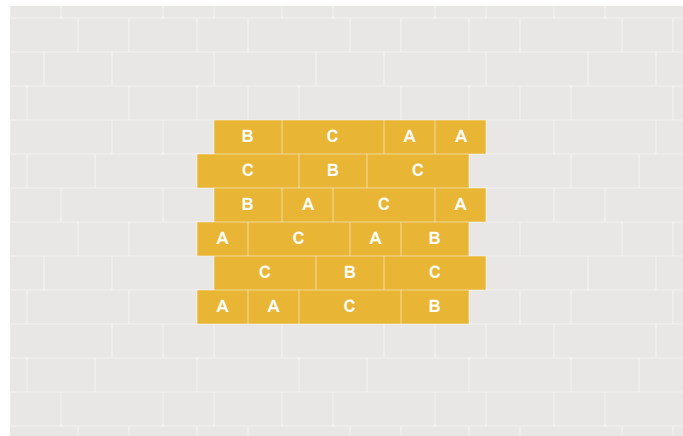

Module	Size (in)	Pcs required	Coverage
A	12 x 18	8	25%
B	12 x 24	6	25%
C	12 x 36	8	50%

CHARLESTON

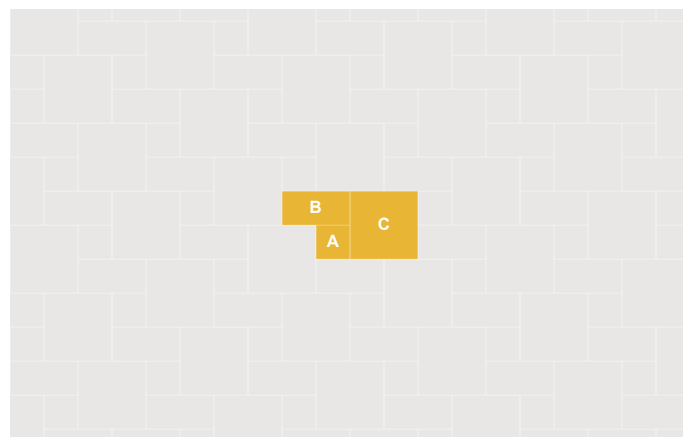

Module	Size (in)	Pcs required	Coverage
A	12 x 12	1	14%
B	12 x 24	1	29%
C	24 x 24	1	57%

PAVER LAYOUT DESIGNS



SHERBROOKE (PRE-PACKAGED 3-PIECE)

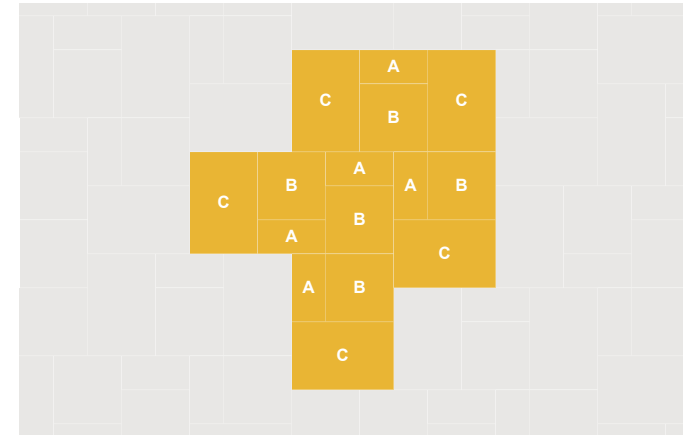

Module	Size (in)	Pcs required	Coverage
A	12 x 24	5	17%
B	24 x 24	5	33%
C	24 x 36	5	50%

CONCORD

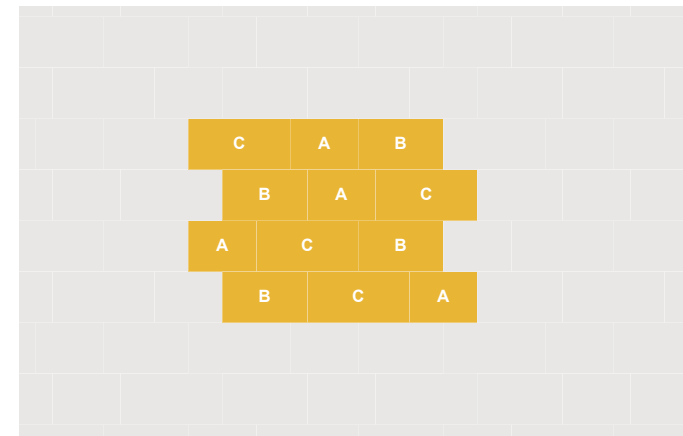

Module	Size (in)	Pcs required	Coverage
A	18 x 24	4	27%
B	18 x 30	4	33%
C	18 x 36	4	40%

MONTPELIER (PRE-PACKAGED 3-PIECE)

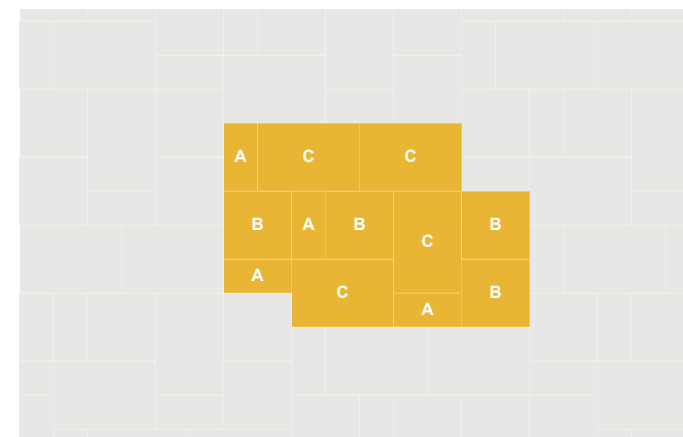

Module	Size (in)	Pcs required	Coverage
A	12 x 24	4	17%
B	24 x 24	4	33%
C	24 x 36	4	50%

PAVER LAYOUT DESIGNS



NEWPORT (PRE-PACKAGED 3-PIECE)

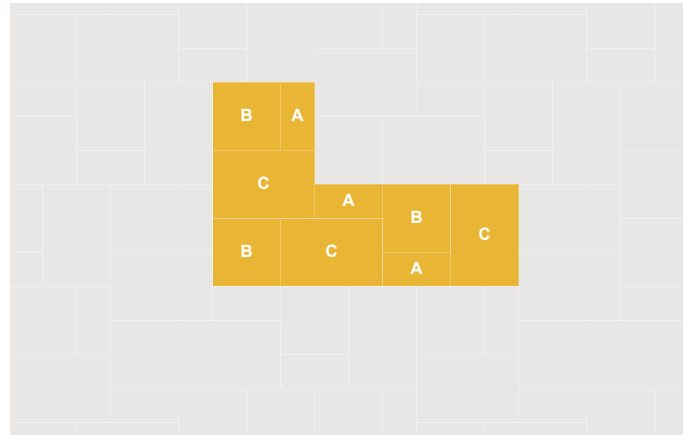

Module	Size (in)	Pcs required	Coverage
A	12 x 24	3	17%
B	24 x 24	3	33%
C	24 x 36	3	50%

PORTLAND (PRE-PACKAGED 4-PIECE)

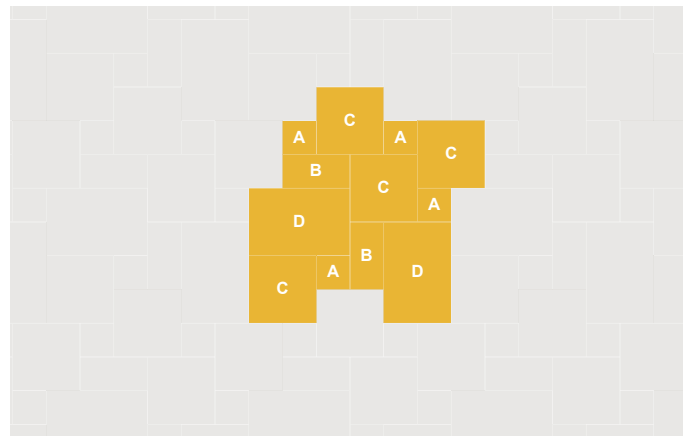

Module	Size (in)	Pcs required	Coverage
A	12 x 12	4	11%
B	12 x 24	2	11%
C	24 x 24	4	45%
D	24 x 36	2	33%

RICHMOND (PRE-PACKAGED 3-PIECE)

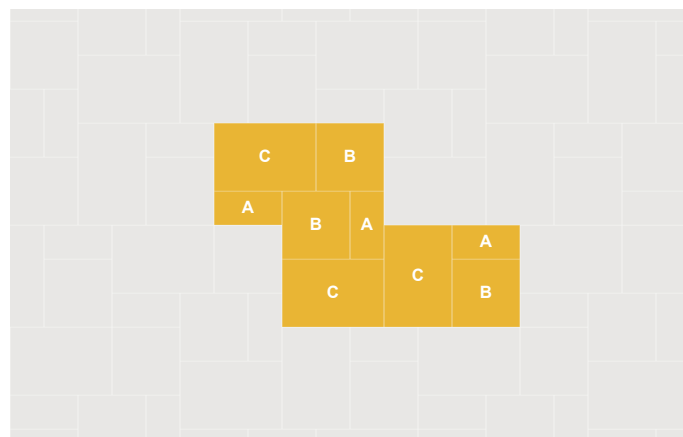

Module	Size (in)	Pcs required	Coverage
A	12 x 24	3	17%
B	24 x 24	3	33%
C	24 x 36	3	50%

PAVER LAYOUT DESIGNS



SAVANNAH

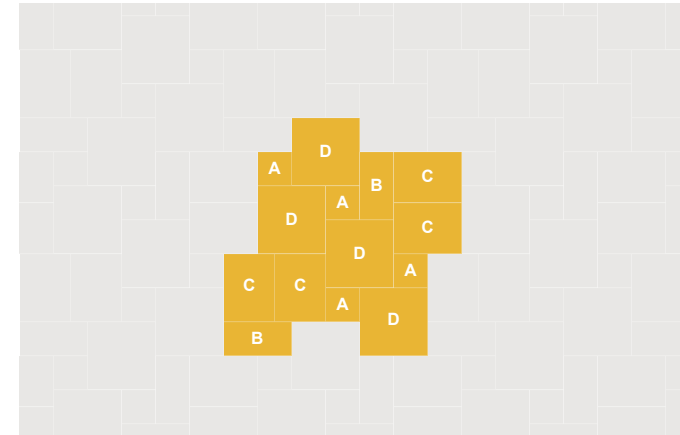

Module	Size (in)	Pcs required	Coverage
A	12 x 12	4	11%
B	12 x 24	2	11%
C	18 x 24	4	33%
D	24 x 24	4	45%

VINEYARD (PRE-PACKAGED 3-PIECE)

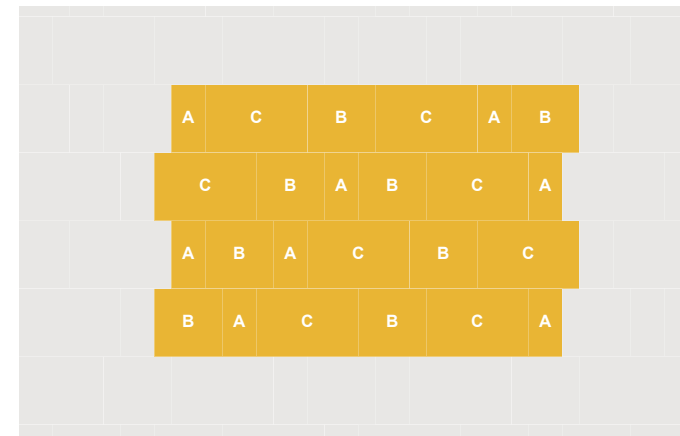

Module	Size (in)	Pcs required	Coverage
A	12 x 24	8	17%
B	24 x 24	8	33%
C	24 x 36	8	50%

WINDSOR (PRE-PACKAGED 3-PIECE)

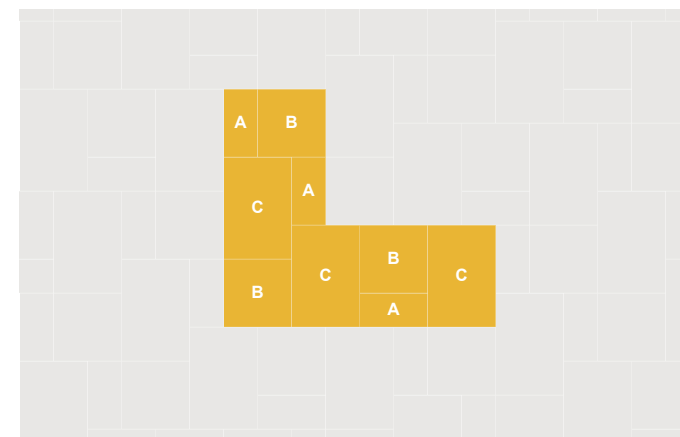

Module	Size (in)	Pcs required	Coverage
A	12 x 24	3	17%
B	24 x 24	3	33%
C	24 x 36	3	50%

PAVER LAYOUT DESIGNS



STACKED BOND 12 x 24

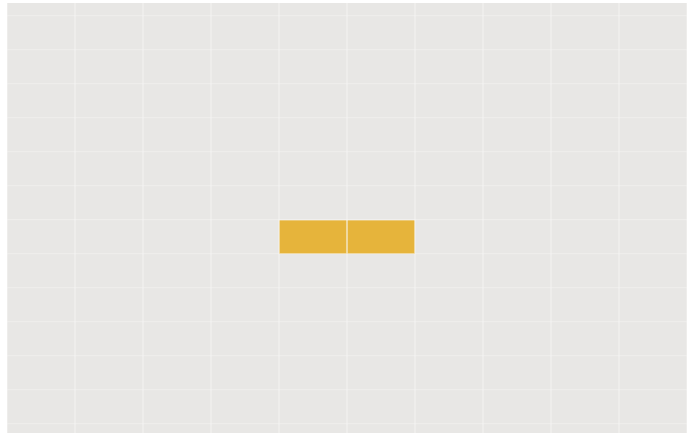

Module	Size (in)
A	12 x 24

PAVER LAYOUT DESIGNS



STACKED BOND 36 x 36

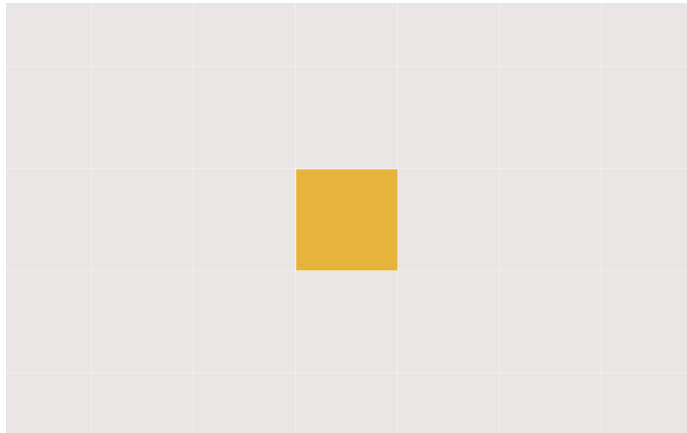

Module	Size (in)
A	36 x 36

STACKED BOND 24 x 24

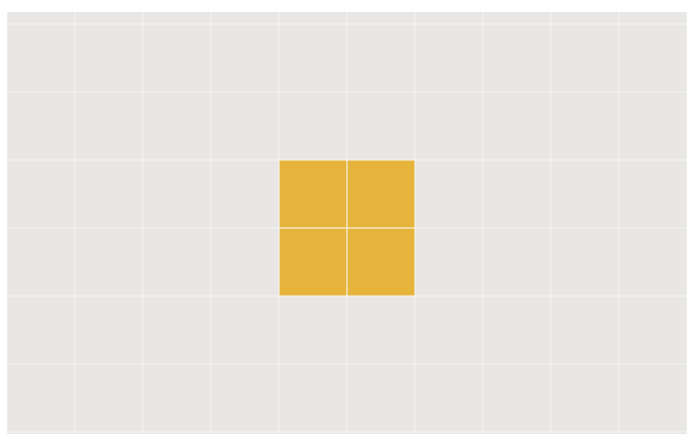

Module	Size (in)
A	24 x 24

HALF-RUNNING BOND 12 x 24

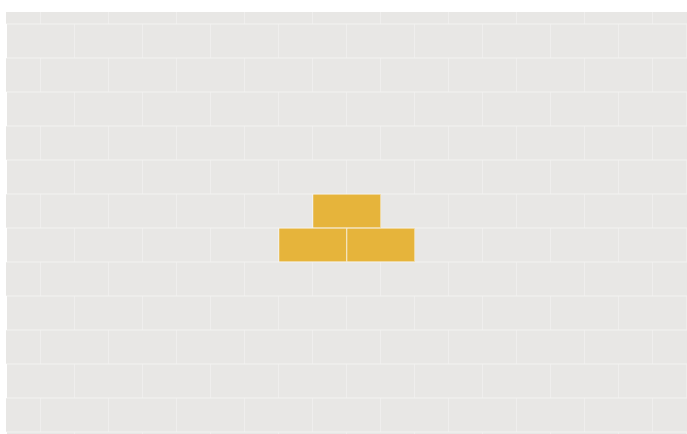

Module	Size (in)
A	12 x 24

STACKED BOND 24 x 48

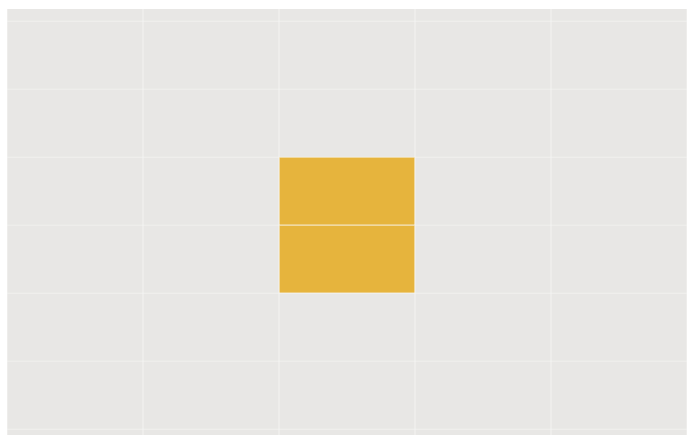

Module	Size (in)
A	24 x 48

HALF-RUNNING BOND 24 x 24

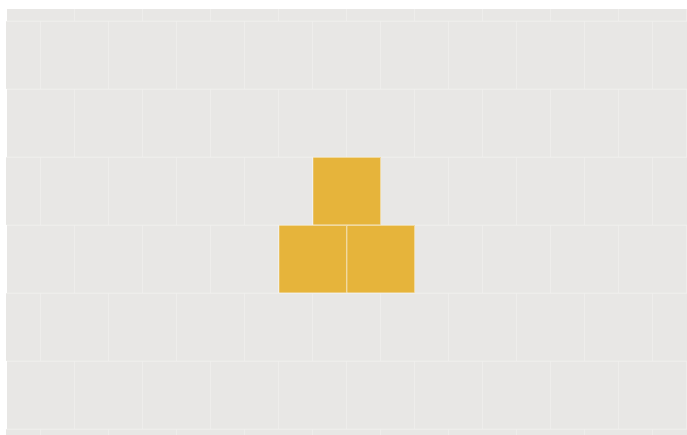

Module	Size (in)
A	24 x 24

PAVER LAYOUT DESIGNS



HALF-RUNNING BOND 24 x 48

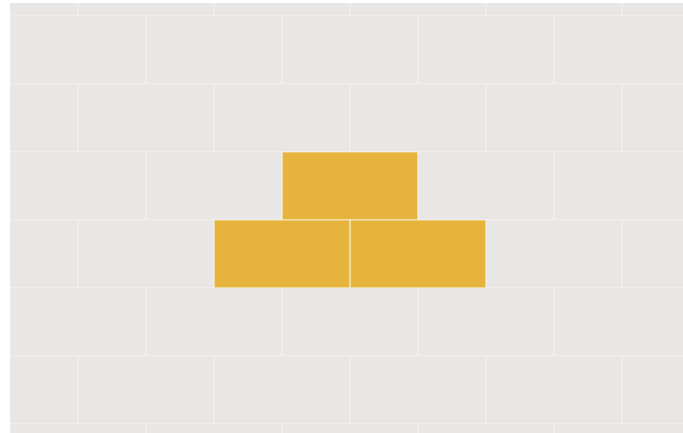

Module	Size (in)
A	24 x 48

HALF-RUNNING BOND 36 x 36

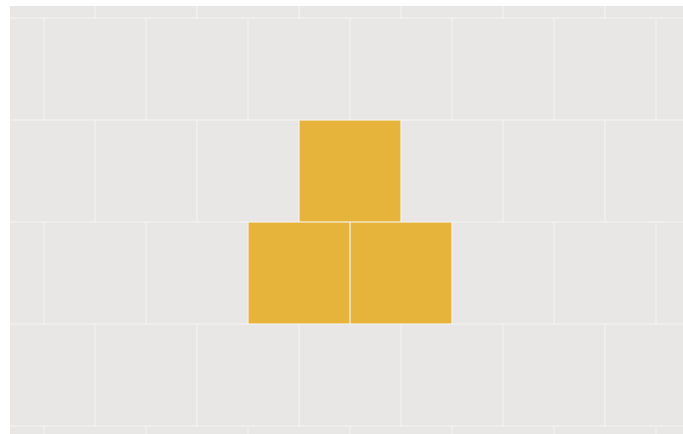

Module	Size (in)
A	36 x 36

PAVERS INSTALLATION GUIDE



INDIANA LIMESTONE - FULL COLOR BLEND™
Limestone - Pavers

STEP-BY-STEP INSTRUCTIONS

NOTE

This installation guide describes the construction of a pedestrian paved surface with natural stone pavers placed on a permeable, open-graded crushed stone bedding layer and over an open-graded base.

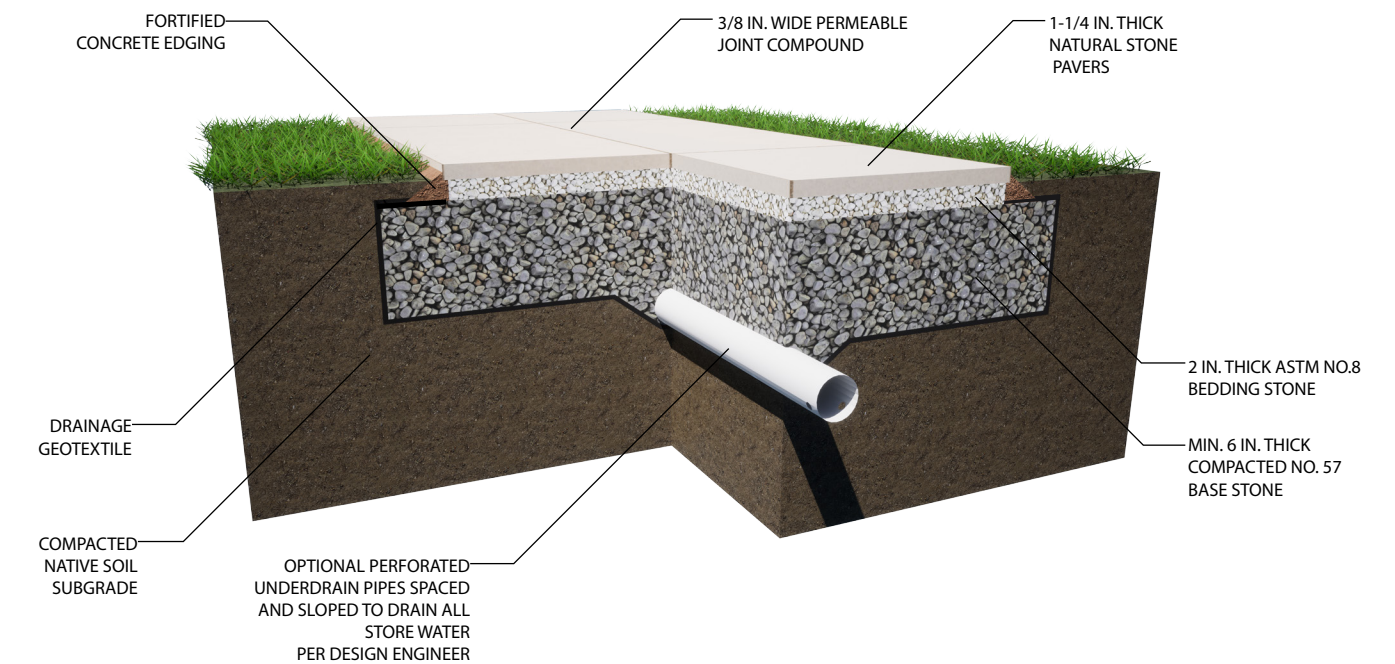

JOB PLANNING

Before undertaking any paver installation work, the location of underground utilities must first be determined on the job site, prior to excavation, by contacting local utility companies to mark locations on site. Identify the area to be excavated and mark out with spray paint. Calculate the total coverage area and allow for a percentage of wastage when ordering materials. As a result of cutting wastage, consider ordering up to an additional 10% of materials to complete the project.

PAVERS

INSTALLATION GUIDE

DELIVERY, STORAGE, AND HANDLING

Comply with ordering instructions and lead-time requirements to avoid construction delays. Store materials in protected area such so that they are kept free from mud, dirt, and other foreign materials. All products must be inspected on arrival. In the unlikely event that material is delivered in less than satisfactory condition, please refer to your dealer immediately, allowing time for faulty material to be replaced.

SOIL CONSIDERATIONS

Gradation of soil on site is an important consideration when determining the performance criteria required for paving. The size and distribution of the particles greatly influence its performance. Soils range from coarse to fine-grained, with sandy soils being coarse and clay soils having the smallest or finest particles, thereby making them less permeable. Perform soil tests to guide base compositions and preparations. ASTM D422, Standard Test method for Particle Size Analysis of Soil Fines is commonly used for sieve analysis of soils. ASTM C136, Standard Test Method for Sieve Analysis of Fine and Coarse Aggregates is common for aggregates.

LAYOUT AND SITE PREPARATION

Excavate unsuitable, unstable, or unconsolidated subgrade material as dictated by soil classification on jobsite and compact the cleared area using fill. Level with densely graded crushed stone aggregate suitable for subbase material, or as otherwise directed by Specifying Authority.

EXCAVATION

Always call any local utilities to ensure your work area is clear of any underground cables or wires before you dig. Consult with local utilities about options for moving services, if necessary. Begin excavating down to a depth of 8 to 10 inches. For a walkway or patio, it is recommended to have a base of at least 6 to 8 inches minimum thickness to ensure stability and durability. Ensure that a $\frac{3}{16}$ -inch slope per foot is maintained away from the foundation during excavation away from the foundation for proper drainage. This slope will be used throughout the whole installation. Extend the excavation beyond the paver edge by the thickness of the base. Ensure proper compaction of the soil. Cover the bottom of the excavation with a geotextile membrane to keep the subsoil and the stone layer separated.

BASE

Open-graded base, typically ASTM No. 57 stone ($\frac{3}{4}$ -inch clean, washed stone) that is at least 6 inches or 150mm thick. Moisten, spread, and compact the No. 57 base layer in 4 inch lifts. This aggregate base uses angular and symmetrical aggregates with no fine particles. When compacting an open-graded base, it's important to make sure that the aggregates are tightly locked together. In low infiltration soils or installations with impermeable liners, some or all drainage is directed to an outlet via perforated underdrain pipes put in place per the drawings prior to or during placement of the base, depending on their location. Care must be taken not to damage underdrain pipes during compaction and paving.

SETTING BED

Open-graded crushed stone bedding layer, typically ASTM No. 8 stone or No. 9 ($\frac{3}{4}$ -inch to $\frac{1}{4}$ -inch clean, washed stone) that is 2 inches or 50mm thick. Moisten, spread, compact and screed the No. 8 stone

PAVERS

INSTALLATION GUIDE

bedding material maintaining a consistent 2-inch thickness. Fill voids left by removed screed rails with No. 8 stone. Do not subject screeded bedding material to any pedestrian traffic before the installation of the paving unit.

LAYING PAVERS

There are different variations and colors with natural stone providing a unique range that you just can't get with an engineered product. Work out of multiple pallets to blend the stones effectively in the installation.

Lay the paving units in the patterns dictated by the design. Use $\frac{3}{8}$ -inch spacers between paver edges to maintain straight pattern lines. Fill gaps at the edges of the paved area with cut units. Cut natural stone pavers with a masonry saw using a diamond blade. Always make sure to use safety glasses and hearing protection. Ensure that the blade used on the saw has sufficient depth of cut for your application. After the pavers are laid, remove excess aggregate on the surface by sweeping pavers clean. Check final elevations for conformance to the drawings. We do not recommend using a vibratory plate compactor on any natural stone pavers.

JOINT COMPOUND

Fill the opening and joints with a permeable joint compound following the manufacturer's application process and guidelines. Please note that some jointing compounds can retain moisture, damage, or stain natural stone pavers if they are not used correctly. Always seek specialist advice from your Polycor sales representative if you are in doubt. It is your responsibility to determine if the permeable joint compound you selected can be used for the intended purpose. When in doubt, test in an inconspicuous area beforehand to determine if there is any change to the stone's appearance.

EDGE RESTRAINTS

Permeable projects require special edge restraints. To complete the project, use a permeable fortified concrete bonded edging. Fortified concrete edging can be applied just under the pavers, then hand-troweled to the wedge shape for a successful edge on permeable base projects. Please note that some concrete edging can retain moisture, damage, or stain natural stone pavers if they are not used correctly, and you should always seek specialist advice from your Polycor sales representative if you are in doubt.

SEALERS

To maintain the aesthetic beauty of the original installation, applying an impregnating sealer coating to the paved surface might be required. While it is not a requirement to seal natural stone, an impregnating sealer application may aid in cleaning the surface should it become dirty. Please note that some topical sealers and other materials can damage or stain natural stone pavers if they are not used correctly. Always seek specialist advice from your Polycor sales representative if you are in doubt. You are responsible for determining if the sealer you selected is suitable for natural stone. Test in an inconspicuous area first before applying and using per the accordance with the manufacturer's recommendations.

EFFLORESCENCE

Some natural stone pavers may experience efflorescence when in contact with joint compounds, bedding and fortified concrete edging. Efflorescence will naturally disappear over time if the moisture source is eliminated or controlled. For additional information, consult our Care and Maintenance guide.

POOL COPING

PRODUCT DATA SHEET



Scan me for more info.

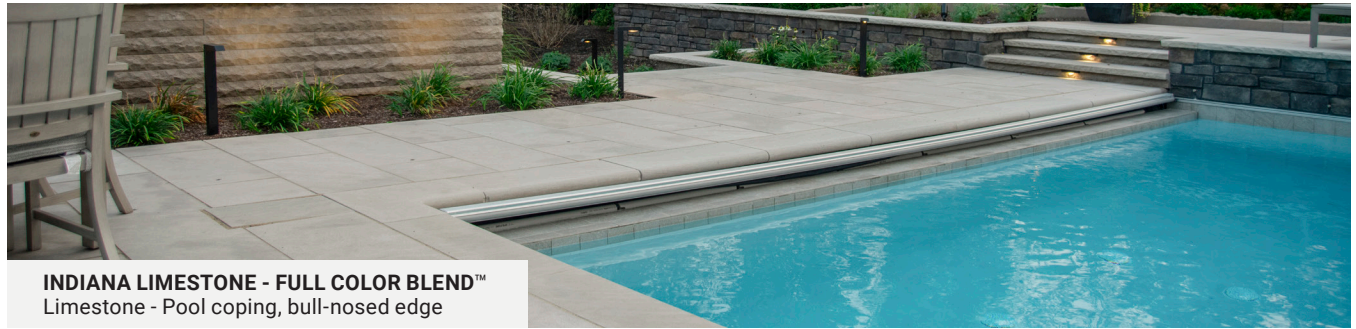

INDIANA LIMESTONE - FULL COLOR BLEND™
Limestone - Pool coping, bull-nosed edge

A complement to the surrounding landscape, natural stone pool coping is as practical as it is attractive. Natural stone is durable and resists freeze-thaw cycles.

BULL-NOSED EDGE

Shape	Dimensions	Thickness
	13 1/8" x 48"	2 1/4"

Only available in **INDIANA LIMESTONE - FULL COLOR BLEND™**



CHAMFERED EDGE

Shape	Dimensions	Thickness
	12" x 24"	2 1/4" Limestone 2" Granite 2" Marble
	16" x 24"	2 1/4" Limestone 2" Granite 2" Marble

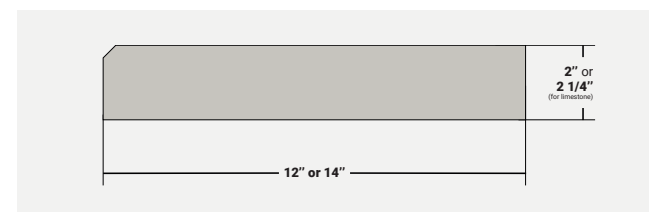
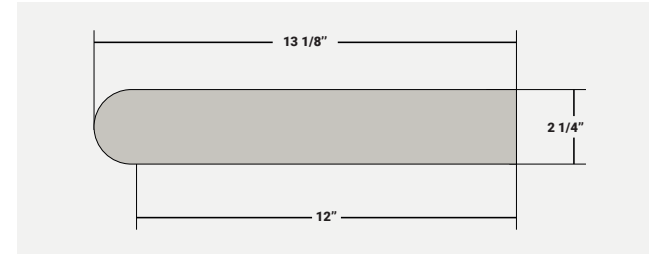

STONES

- INDIANA LIMESTONE - FULL COLOR BLEND™***
Limestone - Smooth top, Sawn sides
- INDIANA LIMESTONE - FOSSIL BEIGE™***
Limestone - Smooth top, Sawn sides
- CALEDONIA™ NEW**
Granite - Thermal top, Sawn sides
- EASTERN GRAY™**
Granite - Thermal top, Sawn sides
- SAINT HENRY BLACK™**
Granite - Thermal top, Sawn sides
- GEORGIA MARBLE™ PEARL GREY™**
Marble - Sandblasted top, Sawn sides

*Note: Cement-based damp-proofing should be applied to the back and all unexposed sides of the pavers to protect the limestone from moisture and prevent staining.

POOL COPING

PACKAGING INFORMATION

POOL COPING							
Products	Size	Thickness	Quantity per crate	Units per crate	Weight per crate (Lbs)		
					Limestone	Granite	Marble
Bull-nosed edge	13 1/8" x 48"	2 1/4"	48 ln.ft.	12	1,478	N/A	N/A
Chamfered edge	12" x 24"	2 1/4" Limestone 2" Granite and Marble	48 ln.ft.	24	1,356	1,375 - 1,478	1,475
	16" x 24"	2 1/4" Limestone 2" Granite and Marble	48 ln.ft.	24	1,788	1,814 - 1,950	1,867

STEPS & TREADS

Step up outdoor spaces with natural stone.

Nothing compares to the classic beauty and durability of natural stone steps and treads.

6" Steps	76
Treads	78



6" STEPS

PRODUCT DATA SHEET



Scan me for more info.



INDIANA LIMESTONE - FULL COLOR BLEND™
Limestone - 6" steps

6" steps add a distinct sense of permanence to hardscaped areas. Create durable and timeless step elements from single pieces of natural stone.

Shape	Dimensions	Thickness
	16" x 36"	6"
	16" x 48"	6"
	16" x 60"	6"

STONES

- INDIANA LIMESTONE - FULL COLOR BLEND™***
Limestone - Smooth top, Split-face
- EASTERN GRAY™**
Granite - Thermal top, Split-face
- GEORGIA MARBLE™ PEARL GREY™**
Marble - Sandblasted top, Split-face

*Note: Cement-based damp-proofing should be applied to the back and all unexposed sides of the pavers to protect the limestone from moisture and prevent staining.

DIAGRAM OF 6" STEPS

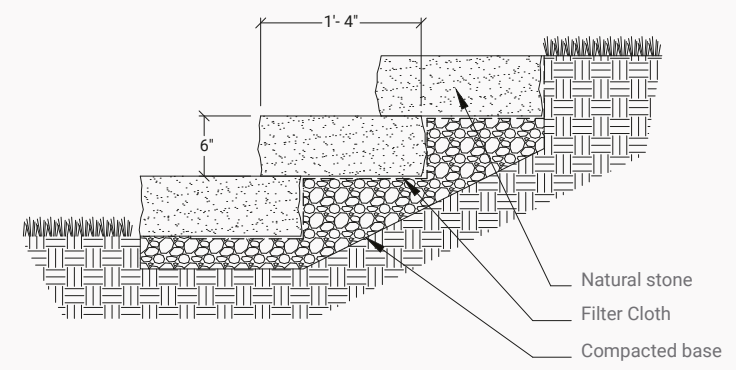

We recommend a minimum overlap of 1 to 3 inch for steps in your project.

6" STEPS

PACKAGING INFORMATION

STEPS							
Products	Size	Thickness	Quantity per crate	Units per crate	Weight per crate (Lbs)		
					Limestone	Granite	Marble
3 ft.	16" x 36"	6"	18 ln.ft.	6	1,728	2,040	2,124
4 ft.	16" x 48"	6"	24 ln.ft.	6	2,304	2,700	2,812
5 ft.	16" x 60"	6"	30 ln.ft.	6	2,880	3,360	3,500

TREADS

PRODUCT DATA SHEET



Scan me for more info.



INDIANA LIMESTONE - FULL COLOR BLEND™
Limestone - Treads

Natural stone treads add a luxury finish to standard steps. They are perfectly adapted to northern climates, widely sought after for their superior strength and durability.

Shape	Dimensions	Thickness
	12" x 48"	2"
	12" x 72"	2"
	12" x 96"	2"
	14" x 48"	2"
	14" x 72"	2"
	14" x 96"	2"

Granite and marble treads are true-to-size. Limestone is one inch longer to allow for field dressing. Other sizes and finishes of **INDIANA LIMESTONE - FULL COLOR BLEND™** limestone available upon request.

STONES

- INDIANA LIMESTONE - FULL COLOR BLEND™**
Limestone - Smooth top, Rock-face
- EASTERN GRAY™**
Granite - Thermal top, Split-face

*Note: Cement-based damp-proofing should be applied to the back and all unexposed sides of the treads to protect the limestone from moisture and prevent staining.

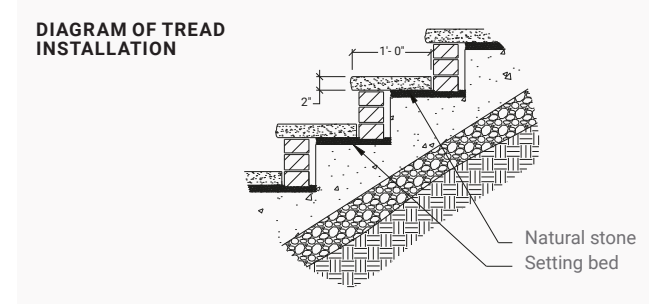

TREADS

PACKAGING INFORMATION

TREADS						
Products	Size	Thickness	Quantity per crate	Units per crate	Weight per crate (Lbs)	
					Limestone	Granite
1 ft. x 4 ft.	12" x 48"	2"	56 ln.ft.	14	1,440	1,550
1 ft. x 6 ft.	12" x 72"	2"	84 ln.ft.	14	2,160	2,320
1 ft. x 8 ft.	12" x 96"	2"	112 ln.ft.	14	2,880	3,090
1.17 ft x 4 ft.	14" x 48"	2"	56 ln.ft.	14	1,680	1,807
1.17 ft x 6 ft.	14" x 72"	2"	84 ln.ft.	14	2,522	2,705
1.17 ft x 8 ft.	14" x 96"	2"	112 ln.ft.	14	3,360	3,603

WALLS & CAPS

Set your space apart.

Enhance and protect your property with natural stone accents. Stone walls and caps are the perfect balance between aesthetic and performance.

Garden Walls	82
Wall Caps	84
Pillar Caps	86

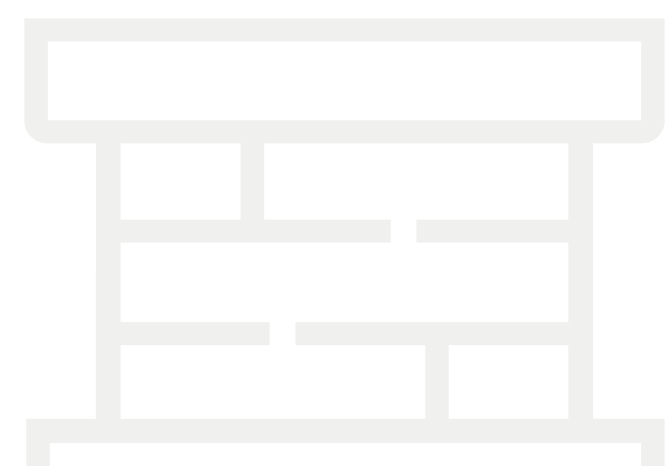

GARDEN WALLS

PRODUCT DATA SHEET



Scan me for more info.



INDIANA LIMESTONE - FULL COLOR BLEND™
Limestone - Garden walls

Garden walls can add depth to any space. This dry-stacked, non-retaining product is ideal for flower beds and landscaping elements.

Shape	Dimensions	Thickness
	8" x random length	3"
	8" x random length	6"

STONES

- INDIANA LIMESTONE - FULL COLOR BLEND™***
Limestone - Split-face
- INDIANA LIMESTONE - FOSSIL BEIGE™***
Limestone - Split-face
- GEORGIA MARBLE™ PEARL GREY™**
Marble - Split-face

*Note: Cement-based damp-proofing should be applied to the back and all unexposed sides of the pavers to protect the limestone from moisture and prevent staining.

GARDEN WALLS

PACKAGING INFORMATION

GARDEN WALL							
Products	Size	Depth	Quantity per ton		Units per crate	Weight per crate (Lbs)	
			Limestone	Marble		Limestone	Marble
3" Height	3" x random	8"	21 sq.ft.	18 sq.ft.	Varied	4,000 - 4,500	4,000 - 4,500
6" Height	6" x random	8"	21 sq.ft.	18 sq.ft.	Varied	4,000 - 4,500	4,000 - 4,500

WALL CAPS

PRODUCT DATA SHEET



Scan me for more info.



INDIANA LIMESTONE - FULL COLOR BLEND™
Limestone - Wall caps

Wall caps are a unique accent piece for your garden or retaining wall. Versatile and durable, split-face wall caps provide a strong finishing touch to any stone wall design.

Shape	Dimensions	Thickness
	12" x 24"	2"

STONES

- INDIANA LIMESTONE - FULL COLOR BLEND™**
Limestone - Smooth top, Split-face
- INDIANA LIMESTONE - FOSSIL BEIGE™**
Limestone - Smooth top, Split-face
- EASTERN GRAY™**
Granite - Thermal top, Split-face
- GEORGIA MARBLE™ PEARL GREY™**
Marble - Smooth top, Split-face

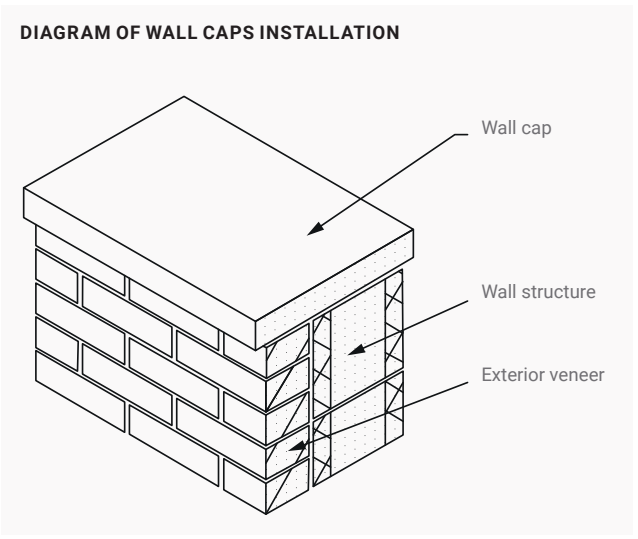

WALL CAPS

PACKAGING INFORMATION

WALL CAPS							
Products	Size	Thickness	Quantity per crate	Units per crate	Weight per crate (Lbs)		
					Limestone	Granite	Marble
2" Wall caps	12" x 24"	2"	108 ln.ft.	54	2,632	3,010	3,136

PILLAR CAPS

PRODUCT DATA SHEET







Scan me for more info.







INDIANA LIMESTONE - FULL COLOR BLEND™
Limestone - Pillar caps

Enhance pillars with the timeless charm of stone. Caps add the finishing touch to any vertical application project.

Shape	Dimensions	Thickness
	20" x 20" *	3"
	24" x 24"	3"
	28" x 28" *	3"
	30" x 30" *	3"

* This size is not available in **INDIANA LIMESTONE - FOSSIL BEIGE™** limestone.

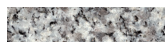
STONES

-  **INDIANA LIMESTONE - FULL COLOR BLEND™**
Limestone - Smooth top, Split-face
-  **INDIANA LIMESTONE - FOSSIL BEIGE™**
Limestone - Smooth top, Split-face (only available in 24" x 24")
-  **EASTERN GRAY™**
Granite - Thermal top, Split-face
-  **GEORGIA MARBLE™ PEARL GREY™**
Marble - Smooth top, Split-face

PILLAR CAPS

PACKAGING INFORMATION

PILLAR CAPS						
Products	Size	Thickness	Units per crate	Weight per crate (Lbs)		
				Limestone	Granite	Marble
20" Pillar caps	20" x 20"	3"	12	1,233	1,408	1,466
24" Pillar caps	24" x 24"	3"	12	1,761	2,013	2,097
28" Pillar caps	28" x 28"	3"	12	2,385	2,728	2,842
30" Pillar caps	30" x 30"	3"	12	2,733	3,127	3,258

OUTDOOR ELEMENTS

A touch of stone for a finished look.

Transform your outdoor space by incorporating natural stone features into your exterior designs. Spend quality time with loved ones around a stunning natural stone fire pit, creating unforgettable memories all year round. With its timeless elegance and durability, natural stone is the perfect choice for achieving a cohesive and sophisticated outdoor design.

Round Fire Pit	90
Square Fire Pit	92
Fire Pit Installation Guide	95

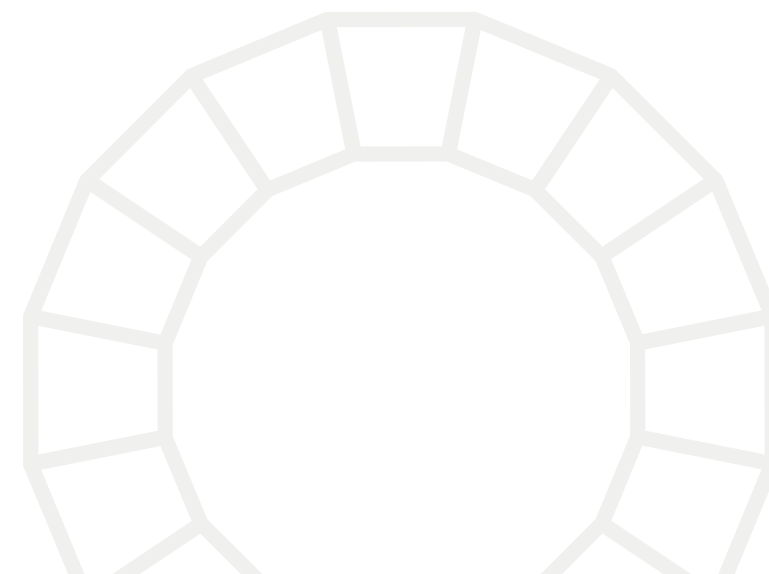

ROUND FIRE PIT

PRODUCT DATA SHEET



Scan me for more info.



EASTERN GRAY™
Granite - Round fire pit

Instantly create a place to entertain with a fire pit kit. Solid granite blocks are easy for both contractors and homeowners to assemble in an afternoon.

Dimensions

Two-tier fire pit with ring (cooking grate included).
Outside diameter: 48"
Inside diameter: 30"

STONE

 **EASTERN GRAY™**
Granite - Thermal top, Split-face sides

Powder coat finished metal components are highly durable with regular maintenance and upkeep.

ROUND FIRE PIT

PACKAGING INFORMATION

ROUND FIRE PITS				
Products	Size	Height	Units per crate	Weight per crate (Lbs)
				Granite
Pre-packaged Round fire pit with ring and cooking grate	48" Outside diameter 30" Inside diameter	14"	32 stones	1,691

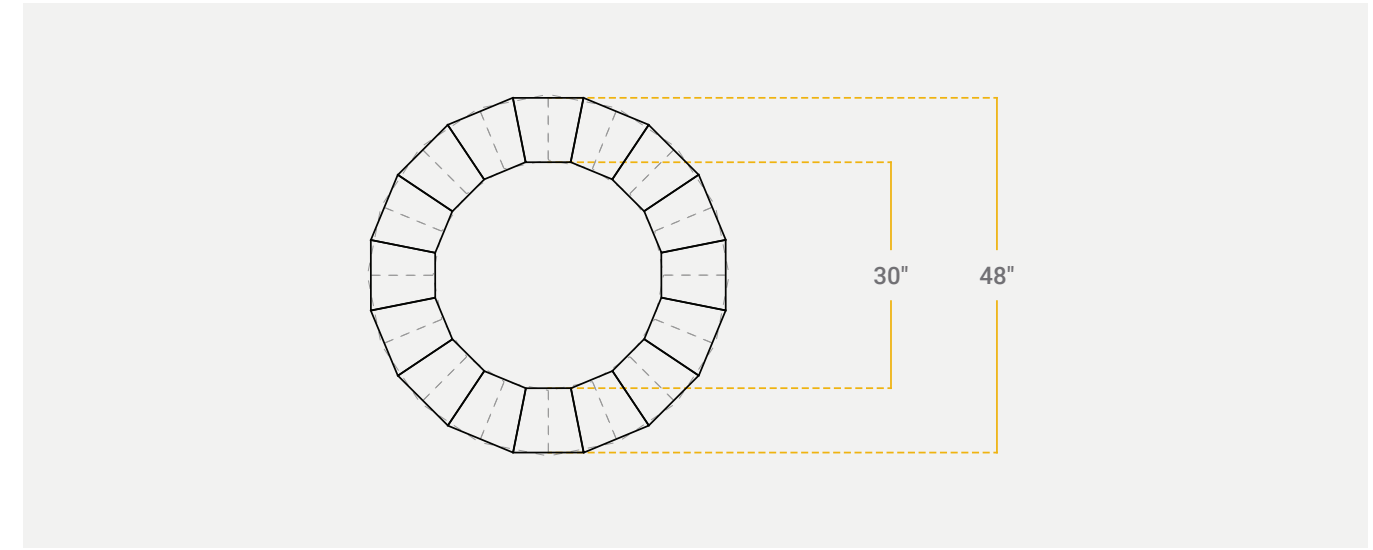

SQUARE FIRE PIT

PRODUCT DATA SHEET



Scan me for more info.



EASTERN GRAY™
Granite - Square fire pit



Safe and durable, square fire pits are suitable to a variety of design styles. Sleek and modern, they will enhance any outdoor space. Pick it up in the morning and you will be roasting s'mores by dusk.

SQUARE FIRE PIT

Sold in an easy-to-install 21-piece kit. Metal insert included.

Dimensions	Height
43" x 43"	14"

STONES

-  **EASTERN GRAY™**
Granite - Thermal top, Split-face sides
-  **SAINT HENRY BLACK™**
Granite - Thermal top, Thermal sides

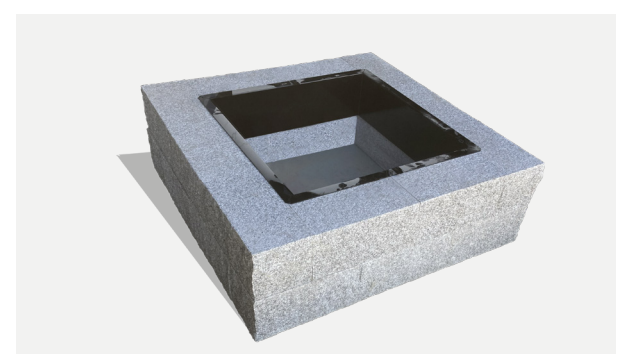

Powder coat finished metal components are highly durable with regular maintenance and upkeep.

SQUARE FIRE PIT

PACKAGING INFORMATION

SQUARE FIRE PITS				
Products	Size	Height	Units per crate	Weight per crate (Lbs)
				Granite
Pre-packaged Square fire pit with ring	43" x 43"	14"	20 stones	1,538 - 1,638

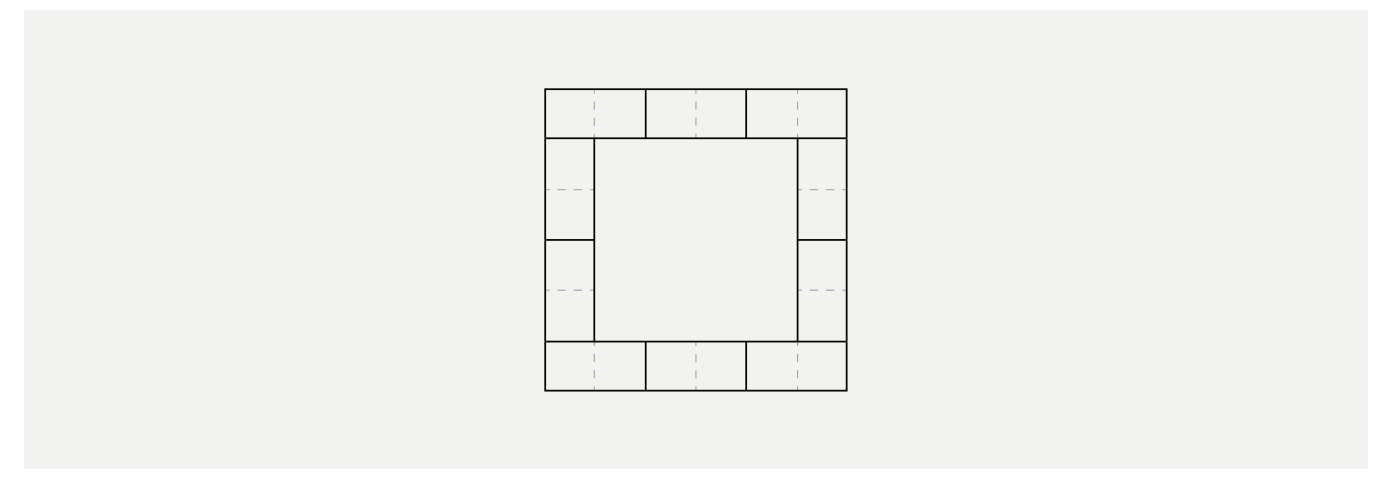

ROUND FIRE PIT

INSTALLATION GUIDE

STEP-BY-STEP INSTRUCTIONS

These simple step-by-step instructions will make assembling your fire pit easy and accurate.

1. Excavate a circular area approximately 4 to 6 feet in diameter and at least 6 inches deep. Fill with processed gravel or mason sand, compacting until level. Dig a hole in the center of this circle approximately 12 inches in diameter and 24 inches deep, and fill it with crushed stone. This will allow for proper drainage.
 - a. If you are building your fire pit on top of a solid surface, such as a patio with stone pavers, remove the pavers in the middle of the circle to dig the required hole, then pitch the remaining pavers that are within the circle toward the hole for proper drainage.
2. Since granite is a natural material, the fire pit blocks may vary in thickness, which is well within the standard industry guidelines for cut granite products.
 - a. Before moving on to step 3, sort through the blocks and make groups of 16 that have a similar thickness. Reserve the most consistent blocks for use as your middle and/or top layers. Use the most inconsistent blocks as the bottom layer so that you can adjust the gravel to create a level surface.
 - b. It may be necessary to shim certain layers for them to remain level. We recommend thin plastic shims.
3. Using the metal ring as a guide, place 16 granite fire pit blocks around the ring, which will create a 30-inch inside diameter circle. Adjust the fire pit blocks as needed so that they are tight together and level. Remove the metal ring.
4. Install the second layer of fire pit blocks on top of the first layer, overlapping blocks as you go to form a solid bond. Install the metal fire ring into this second layer to ensure that you have a good, tight fit.
5. Fill the interior of the fire pit with processed gravel or mason sand. Compact the layers of gravel every 4 inches until you reach the bottom of the flange of the metal ring. Readjust stones as needed to create a good fit.
6. For added stability, you can use landscape adhesive to adhere the top row of blocks to the row below it.
7. Light a fire* and enjoy your quality fire pit from Polycor!

* Never use gasoline or other accelerants to start the fire.

Our granite blocks are protected with sand and the metal fire ring, but keep your fire small, as large fires and intense heat may cause the granite blocks to spall or crack.

Always attend the fire, and have a hose or bucket of water nearby for emergencies.

When you are finished enjoying your fire, be sure to fully extinguish it.

Do not leave children unattended around open flames or hot embers.

Never throw foreign objects into the fire.

ROUND FIRE PIT INSTALLATION GUIDE

ROUND FIRE PIT INSTALLATION GUIDE

STEP 1: First Row

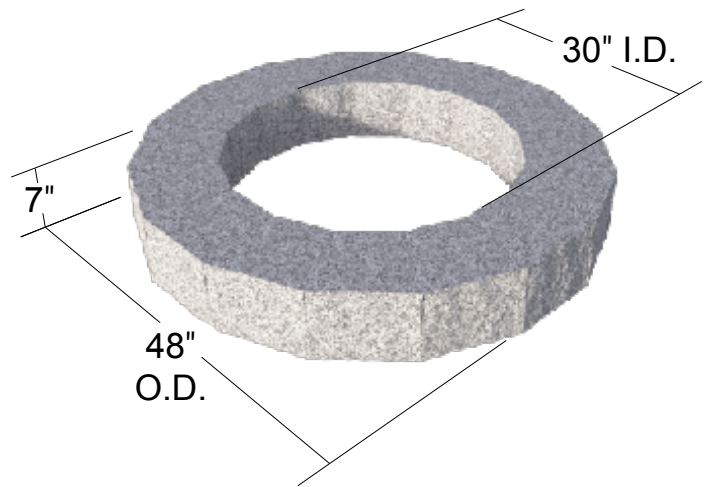

Tapered Block
16 pcs

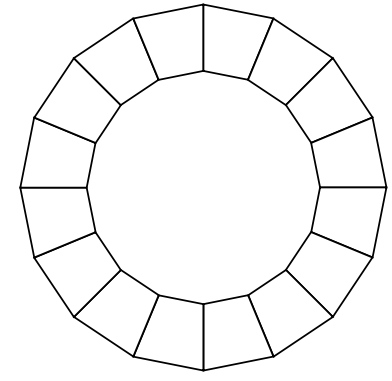
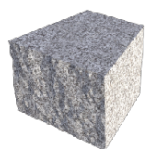

STEP 3: Metal Insert

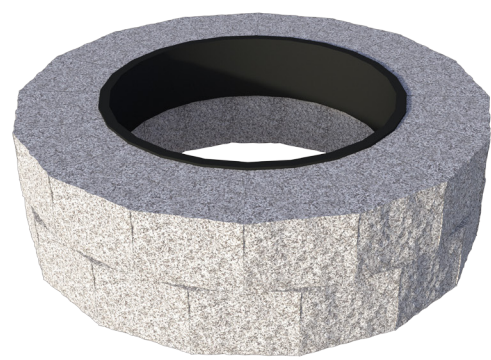

Metal insert
1 pc



STEP 2: Second Row

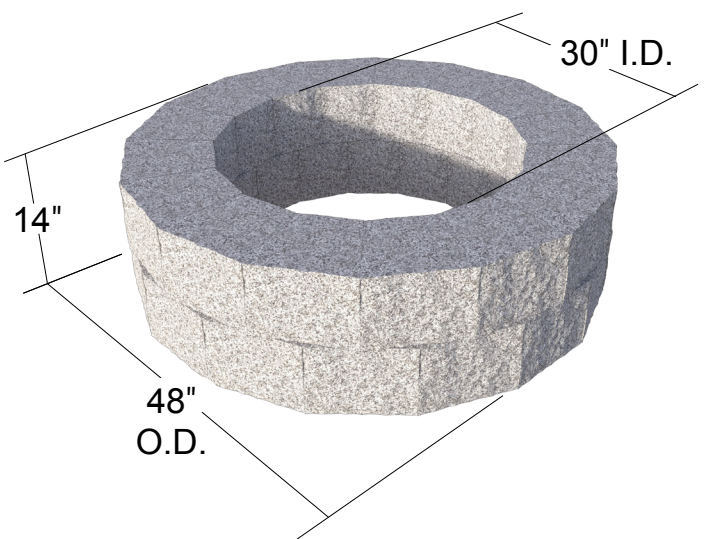

Tapered Block
16 pcs

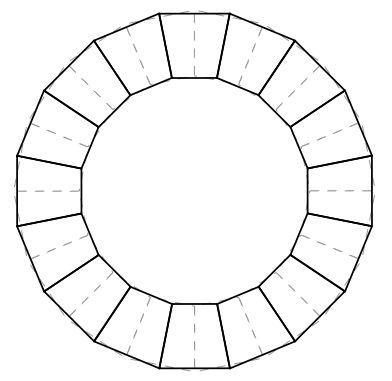
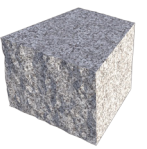

STEP 4: Gravel

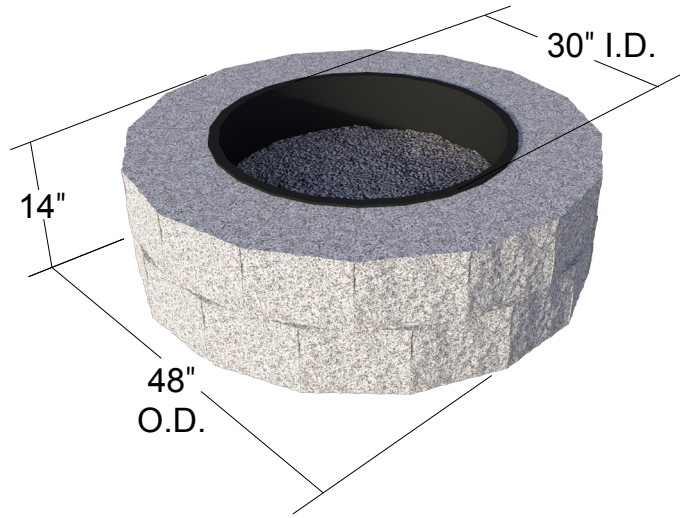

SQUARE FIRE PIT

INSTALLATION GUIDE

SQUARE FIRE PIT

INSTALLATION GUIDE

Refer to the Round Fire Pit Installation Guide to prepare the base before installing your square fire pit.

STEP 1: First Row

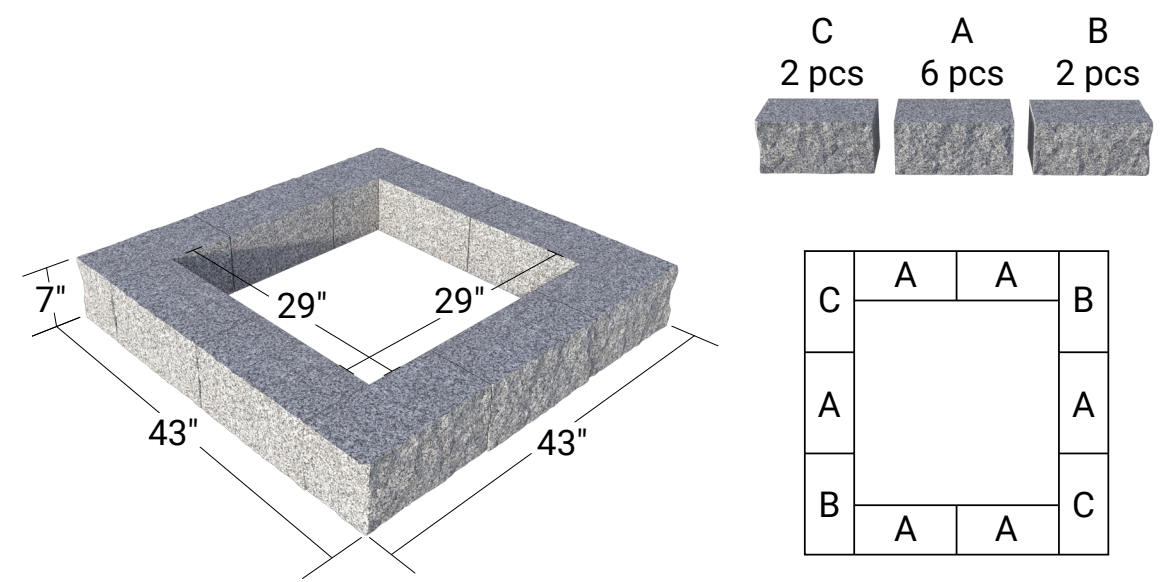

STEP 2: Second Row

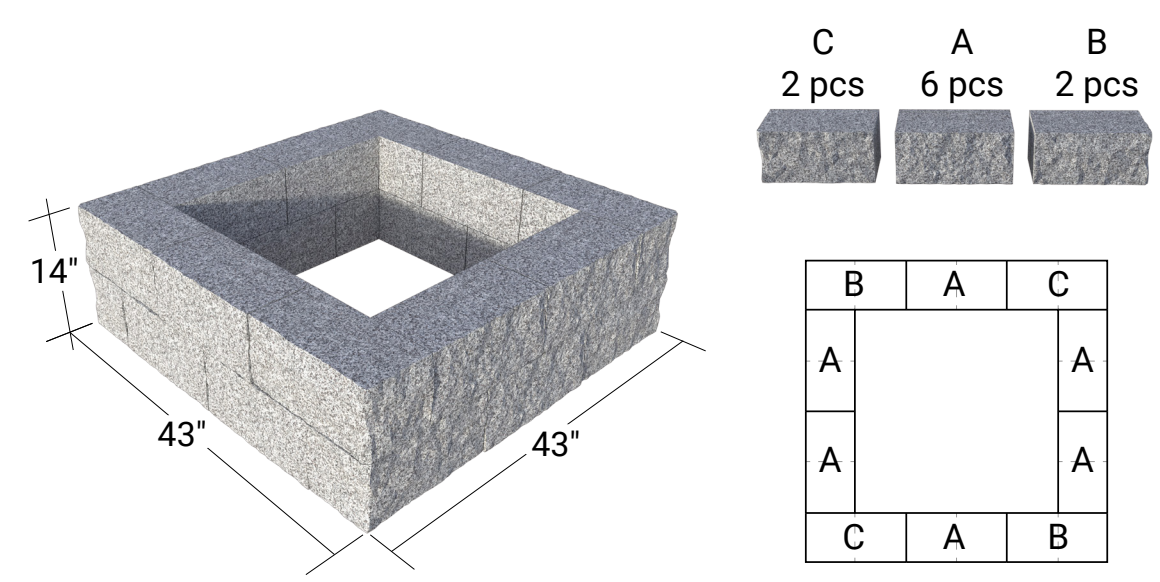

STEP 3: Metal Insert

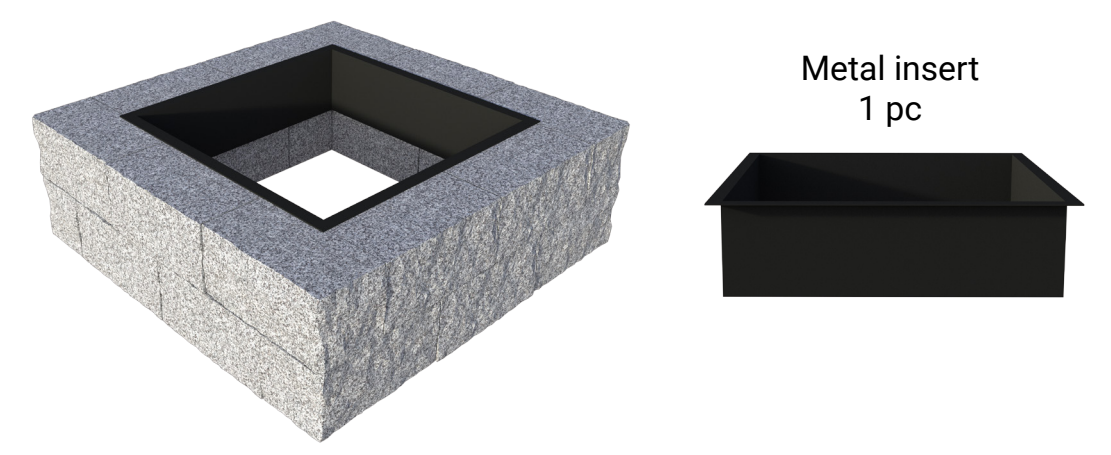

STEP 4: Gravel

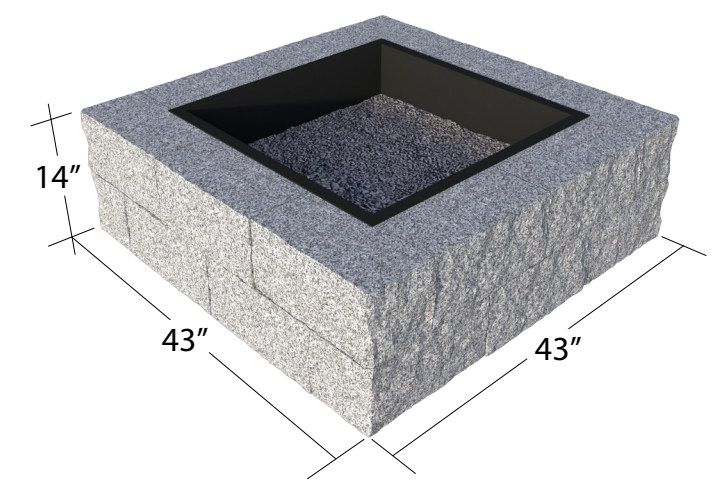

TECHNICAL DATA

Professional specs on all Polycor natural stone products for hardscapes and masonry projects.
Get the detailed technical data you need on our silica-free stones and Solar Reflectance Index for Polycor Hardscapes & Masonry stone.

ASTM Test Results NEW	102
SRI Test Results NEW	106



PHYSICAL TEST RESULTS

ASTM INFORMATION



INDIANA LIMESTONE - FULL COLOR BLEND™ limestone		IMPERIAL	METRIC
Absorption by weight	ASTM C97	7.5 %	7.5 %
Density	ASTM C97	144 lb/ft³	2,306.66 kg/m³
Compressive strength	ASTM C170	4,000 Psi	27.58 MPa
Modulus of rupture	ASTM C99	700 Psi	4.83 MPa



INDIANA LIMESTONE - FOSSIL BEIGE™ limestone		IMPERIAL	METRIC
Absorption by weight	ASTM C97	7.5 %	7.5 %
Density	ASTM C97	144 lb/ft³	2,306.66 kg/m³
Compressive strength	ASTM C170	4,000 Psi	27.58 MPa
Modulus of rupture	ASTM C99	700 Psi	4.83 MPa



INDIANA LIMESTONE - MAVISE™ limestone		IMPERIAL	METRIC
Absorption by weight	ASTM C97	5.96%	5.96%
Density	ASTM C97	139.48 lb/ft³	2,234.26 kg/m³
Compressive strength	ASTM C170	7,700 Psi	50 MPa
Modulus of rupture	ASTM C99	926 Psi	6.38 MPa

PHYSICAL TEST RESULTS

ASTM INFORMATION



CALEDONIA™ granite		IMPERIAL	METRIC
Absorption by weight	ASTM C97	0.12 %	0.12 %
Density	ASTM C97	169 lb/ft³	2,710 kg/m³
Compressive strength	ASTM C170	28,021 Psi	193.20 MPa
Modulus of rupture	ASTM C99	1,711 Psi	11.80 MPa



EASTERN GRAY™ granite (USA)		IMPERIAL	METRIC
Absorption by weight	ASTM C97	0.182 %	0.182 %
Density	ASTM C97	164.01 lb/ft³	2,627.19 kg/m³
Compressive strength	ASTM C170	34,789 Psi	239.90 MPa
Modulus of rupture	ASTM C99	2,097 Psi	14.46 MPa

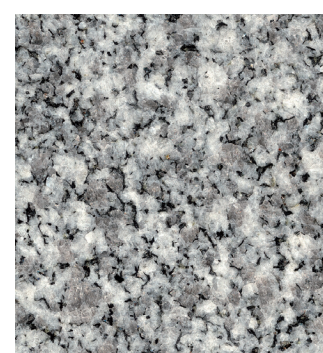

EASTERN GRAY™ granite (CAN)		IMPERIAL	METRIC
Absorption by weight	ASTM C97	0.30 %	0.30 %
Density	ASTM C97	166 lb/ft³	2,659.90 kg/m³
Compressive strength	ASTM C170	22,644 Psi	156 MPa
Modulus of rupture	ASTM C99	1,631 Psi	11.3 MPa

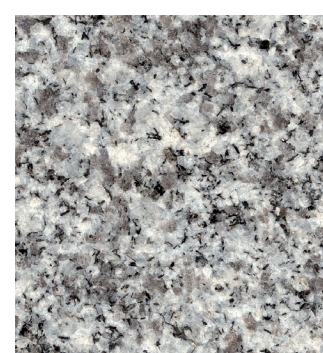

EASTERN GRAY™ granite (USA/CAN)		IMPERIAL	METRIC
Absorption by weight	ASTM C97	0.252 %	0.252 %
Density	ASTM C97	165 lb/ft³	2,643.05 kg/m³
Compressive strength	ASTM C170	17,007 Psi	117.26 MPa
Modulus of rupture	ASTM C99	1,617 Psi	11.15 MPa

PHYSICAL TEST RESULTS

ASTM INFORMATION



NEW

KODIAK BROWN™ granite		IMPERIAL	METRIC
Absorption by weight	ASTM C97	0.10 %	0.10 %
Density	ASTM C97	171lb/ft³	2,739.16 kg/m³
Compressive strength	ASTM C170	25 525 Psi	175.99 MPa
Modulus of rupture	ASTM C99	2,248 Psi	15.50 MPa



NEW

PICASSO™ granite		IMPERIAL	METRIC
Absorption by weight	ASTM C97	0.16 %	0.16 %
Density	ASTM C97	165.2 lb/ft³	2,646.25 kg/m³
Compressive strength	ASTM C170	23,277 Psi	160.49 MPa
Modulus of rupture	ASTM C99	2,364 Psi	16.30 MPa



SAINT HENRY BLACK™ granite		IMPERIAL	METRIC
Absorption by weight	ASTM C97	0.056 %	0.056 %
Density	ASTM C97	177.2 lb/ft³	2,838.47 kg/m³
Compressive strength	ASTM C170	22,242 Psi	153.36 MPa
Modulus of rupture	ASTM C99	1,929 Psi	13.30 MPa

PHYSICAL TEST RESULTS

ASTM INFORMATION

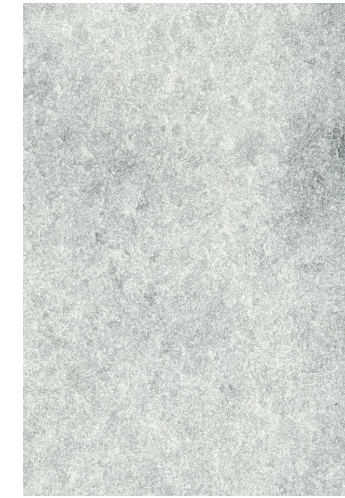

GEORGIA MARBLE™ PEARL GREY™ marble		IMPERIAL	METRIC
Absorption by weight	ASTM C97	0.09 %	0.09 %
Density	ASTM C97	169.4 lb/ft³	2,713.53 kg/m³
Compressive strength	ASTM C170	9,505 Psi	65.53 MPa
Modulus of rupture	ASTM C99	1,374 Psi	9.47 MPa



NEW

GEORGIA MARBLE™ WHITE CHEROKEE™ marble		IMPERIAL	METRIC
Absorption by weight	ASTM C97	0.09 %	0.09 %
Density	ASTM C97	169.4 lb/ft³	2,713.53 kg/m³
Compressive strength	ASTM C170	9,336 Psi	64.37 MPa
Modulus of rupture	ASTM C99	1,365 Psi	9.41 MPa



NEW

SAINT CLAIR™ marble - Fleuri cut		IMPERIAL	METRIC
Absorption by weight	ASTM C97	0.5 %	0.5 %
Density	ASTM C97	168 lb/ft³	2,691.10 kg/m³
Compressive strength	ASTM C170	15,889 Psi	109.55 MPa
Modulus of rupture	ASTM C99	972 Psi	6.70 MPa

SOLAR REFLECTANCE INDEX

Solar Reflectance Index (SRI) is a composite measure that combines a surface's solar reflectance and emittance. Essentially, the SRI indicates how well a surface reflects (reflectance) and releases absorbed solar radiation (emittance). The lower the SRI, the hotter a material is likely to become in the sunlight. High SRI surfaces can help reduce the urban heat island that causes cities to stay warmer, contributing to air pollution and increased energy consumption for air conditioning systems.

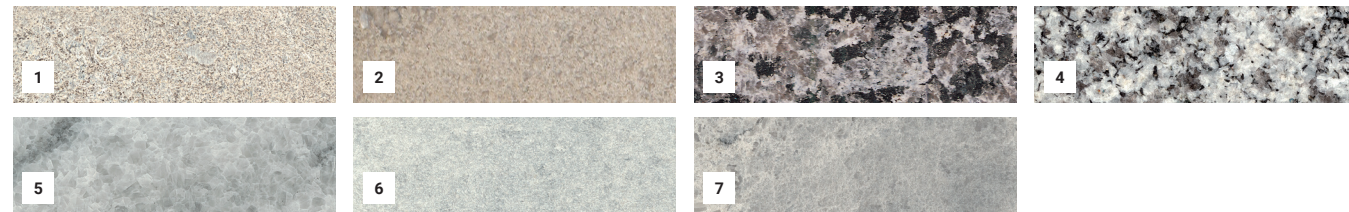

STONE COLOR AND TYPE	INITIAL SOLAR REFLECTANCE	SOLAR REFLECTANCE INDEX (SRI)*	EXCEEDS LEED® 2009 AND LEED® V4 REQUIREMENT
1 - INDIANA Limestone - FULL COLOR BLEND™ limestone	0.47	54	✓
2 - INDIANA Limestone - FOSSIL BEIGE™ limestone	0.47	54	✓
3 - CALEDONIA™ granite	0.29	31	✓
4 - EASTERN GRAY™ granite	0.44	49	✓
5 - GEORGIA MARBLE™ PEARL GREY™ marble	0.54	59	✓
NEW 6 - GEORGIA MARBLE™ WHITE CHEROKEE™ marble	0.59	70	✓
NEW 7 - SAINT CLAIR™ marble, fleuri cut	0.47	56	✓

		INITIAL	3-YEARS AGED
Non-Roof Applications	LEED® 2009 Solar Reflectance Index (SRI)	29	N/A
	LEED® V4 Solar Reflectance	0.33	0.28

The solar reflectance index (SRI) was calculated according to ASTM E1980, Standard Practice for Calculating Solar Reflectance Index of Horizontal and Low-Sloped Opaque Surfaces, assuming a convection coefficient of 12 W/m² · °C (for medium wind speed) and an emittance of 0.9, which is appropriate for non-metallic opaque building materials.

*Solar Reflective Index (SRI) was calculated by CTLGroup, a registered d/b/a of Construction Technology Laboratories, Inc.

SILICA-FREE BUILDING MATERIALS

Silica is a substance found in concrete, mortar, stone, drywall, and other building materials that can cause serious health problems. Our **INDIANA Limestone - FULL COLOR BLEND™**, **INDIANA Limestone - FOSSIL BEIGE™**, **INDIANA Limestone - MAVISE™** limestones, **GEORGIA MARBLE™ PEARL GREY™**, **GEORGIA MARBLE™ WHITE CHEROKEE™** and **SAINT CLAIR™** marbles contain no silica from any of our Indiana limestone or Georgia Marble quarries.

While **INDIANA Limestone - FULL COLOR BLEND™**, **INDIANA Limestone - FOSSIL BEIGE™**, **INDIANA Limestone - MAVISE™** limestones, **GEORGIA MARBLE™ PEARL GREY™**, **GEORGIA MARBLE™ WHITE CHEROKEE™** and **SAINT CLAIR™** marbles do not contain silica, it is still good to limit exposure if a large quantity of dust is created while cutting. Consider dust extraction or wet-cutting while fabricating or field dressing this material and always follow your company's policies and best practices for using PPE.



INDIANA Limestone - FULL COLOR BLEND™ limestone



INDIANA Limestone - FOSSIL BEIGE™ limestone

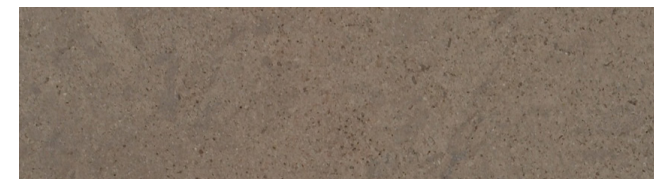

INDIANA Limestone - MAVISE™ limestone



GEORGIA MARBLE™ PEARL GREY™ marble



GEORGIA MARBLE™ WHITE CHEROKEE™ marble



SAINT CLAIR™ marble, fleuri cut

COMPOSITION

STONE SOURCE AND COLOR	CALCIUM CARBONATE	MAGNESIUM OXIDE	SILICA
INDIANA Limestone - FULL COLOR BLEND™ Limestone	99.37% - 99.43%	00.56% - 00.62%	Non-Detect
INDIANA Limestone - FOSSIL BEIGE™ Limestone	99.37% - 99.43%	00.56% - 00.62%	Non-Detect
GEORGIA MARBLE™ PEARL GREY™ Marble	99%	00.99% - 00.62%	Non-Detect

Non-presence of silica (CAS No. 14808-60-7, Cristobalite, Quartz, Tridymite) determined according to NIOSH 7500. Analytical Method and was calculated by Indiana Limestone Institute of America, Inc.

CARE AND MAINTENANCE

It's easy with natural stone.

Polycor natural stones, for a low-maintenance, glamorous look that will stay for generations to come.

Limestone Care and Maintenance	110
Granite Care and Maintenance	112
Marble Care and Maintenance	114



LIMESTONE

CARE AND MAINTENANCE GUIDE



Polycor natural stone products are virtually maintenance-free and, when properly maintained, will provide long-term performance for generations to come.

MAINTENANCE

Limestone surfaces should be kept free of debris and soiling by periodically sweeping or by using a mechanical blower on the surface. When maintaining exterior hardscaping, the ideal is to wash it at periodic intervals (annually, depending on atmospheric conditions) by hosing down the areas with clean water. This will prevent the accumulation of dirt and impurities.

CLEANING

Begin with a simple solution of mild, clear detergent and water. Then, scrub the surface with a soft bristle brush. Rinse with clean water to remove the remaining cleaning solution. If more stubborn soiling exists, use an approved stone cleaner or pH-neutral cleaner approved for limestone. Never use wire brushes, acidic cleaners, bleach, paint remover, or any other type of concrete cleaner. Some stone cleaners also contain small amounts of sealer. These products help to maintain the level of protection. Brushes may be necessary for the removal of certain surface impurities. Soft fiber bristle brushes are recommended.

When dirt has accumulated on older surfaces over an extended period of time, a combination of methods may be necessary to properly clean the limestone. A plain water jet from a power washer will typically remove most accumulation. Adjust the pressure on the machine accordingly and do not exceed 1,200 Psi from a 45-degree fan-shaped nozzle, holding the tip no closer than 12 inches to the face of the stone. No chemicals that could be harmful to the limestone should be used. Note, however, that even high-pressure water can cause damage. Proper pressure, nozzle size, and working distance should be maintained consistently during the process.

One type of accumulation that can occur on limestone, marble, concrete, and other calcareous materials is algae, which appears to be an accumulation of dirt affected by water flowing over the surface.

LIMESTONE

CARE AND MAINTENANCE GUIDE

Algae can be removed by using diluted hydrogen peroxide (1/2 cup in a gallon of water) or vigorously scrubbed over the wetted limestone, if necessary. After cleaning with a soft bristle brush, loosened algae can be hosed away without harming the stone's surface. Test a small, inconspicuous area first to gauge results.

Avoid direct contact with oil-based materials and metals prone to rusting, such as iron, copper, or bronze. In most outdoor applications, with the sources removed, normal sun and rain action will generally remove most stains.

PROTECTIVE COATINGS

To maintain the aesthetic beauty of the original installation, applying an impregnating sealer coating to the limestone surface might be required. While it is not a requirement to seal Polycor natural stone, a sealer application may aid in cleaning the surface should it become dirty. Test in an inconspicuous area before applying, and use per the manufacturer's recommendations.

EFFLORESCENCE

As with many masonry products, efflorescence may occur on the limestone surface. This is typically caused by water carrying soluble salts from below the surface up to the face of the stone. The salts are deposited and recrystallize upon evaporation of the water, leaving a powdery, white salt residue. If the installation is new, brush or blow the powder from the surface with a blower. Repeat as necessary as the stone dries out. Do not use water to remove the powder. Efflorescence will disappear naturally over time, provided that the moisture source is eliminated or controlled. If the residue will not wash off, do not apply chemicals or cleaners to the stone.

For additional information regarding the care and maintenance of limestone, consult the Indiana Limestone Handbook, published by the Indiana Limestone Institute of America, Inc., or visit iljai.com

This guide offers an organized collection of information or a series of options and is not intended as a specific course of action. This document cannot replace education or experience and should be used in conjunction with professional judgment. Not all aspects of this guide may be applicable in all circumstances.

Contact information for third-party cleaning products:



PROSOCO
customer@prosoco.com
800.255.4255
prosoco.com

GRANITE

CARE AND MAINTENANCE GUIDE



Polycor natural stone products are virtually maintenance-free and, when properly maintained, will provide long-term performance for generations to come.

MAINTENANCE

Granite surfaces should be kept free of debris and soiling by periodically sweeping or by using a mechanical blower on the surface. When maintaining exterior hardscaping, the ideal is to wash it at periodic intervals (annually, depending on atmospheric conditions) by hosing down the areas with clean water. This will prevent the accumulation of dirt and impurities. Granite is extremely durable, resists freeze-thaw cycles, is unaffected by ice melting products, and provides durable non-slip surfaces.

CLEANING

Begin with a simple solution of mild detergent, and water. Then, scrub the surface with a soft bristle brush. Rinse with clean water to remove remaining cleaning solution. If more stubborn soiling exists, use an approved stone cleaner or pH neutral cleaner approved for granite. Some stone cleaners also contain small amounts of sealer. These products help to maintain the level of protection. Brushes may be necessary for the removal of certain surface impurities. Soft fiber bristle brushes are recommended.

When dirt has accumulated on older surfaces over an extended period of time, a combination of methods may be necessary to properly clean the granite. A plain water jet, from a power washer, will typically remove most accumulation. Adjust the pressure on the machine accordingly and do not exceed 1,200 Psi, from a 45-degree fan-shaped nozzle, holding the tip no closer than 6 inches to the face of the granite. No chemicals should be used that could be harmful to the granite. Note, however, that even high-pressure water can cause damage. Proper pressure, nozzle size, and working distance should be maintained consistently during the process.

GRANITE

CARE AND MAINTENANCE GUIDE

One type of accumulation that can occur on granite, marble, limestone, concrete, and other calcareous materials is algae, which appears to be an accumulation of dirt affected by water flowing over the surface. This material can be removed by using diluted hydrogen peroxide (1/2 cup in a gallon of water) or vigorously scrubbed over the wetted granite, if necessary. After cleaning with a soft bristle brush, loosened algae can be hosed away without harming the stone's surface. Test a small, inconspicuous area first to gauge results.

Avoid direct contact with oil-based materials and metals prone to rusting such as iron, copper, or bronze. In most outdoor applications, with the sources removed, normal sun and rain action will generally remove most stains.

PROTECTIVE COATINGS

To maintain the aesthetic beauty of the original installation, applying an impregnating sealer coating to the granite surface might be required. While it is not a requirement to seal Polycor natural stone, a sealer application may aid in cleaning the surface should it become dirty. Test in an inconspicuous area before applying, and use per the manufacturer's recommendations.

For additional information regarding care and maintenance of granite, consult the Dimension Stone Design Manual, published by the Natural Stone Institute, or visit naturalstoneinstitute.org

This guide offers an organized collection of information or a series of options and is not intended as a specific course of action. This document cannot replace education or experience and should be used in conjunction with professional judgment. Not all aspects of this guide may be applicable in all circumstances.

MARBLE

CARE AND MAINTENANCE GUIDE



Polycor natural stone products are virtually maintenance-free and, when properly maintained, will provide long-term performance for generations to come.

MAINTENANCE

Marble surfaces should be kept free of debris and soiling by periodically sweeping or by using a mechanical blower on the surface. When maintaining exterior hardscaping, the ideal is to wash it at periodic intervals (annually, depending on atmospheric conditions) by hosing down the areas with clean water. This will prevent the accumulation of dirt and impurities.

CLEANING

Begin with a simple solution of mild detergent, and water. Then, scrub the surface with a soft bristle brush. Rinse with clean water to remove remaining cleaning solution. If more stubborn soiling exists, use an approved stone cleaner or pH neutral cleaner approved for marble. Never use wire brushes, acidic cleaners, bleach, paint remover, or any other type of concrete cleaner. Some stone cleaners also contain small amounts of sealer. These products help to maintain the level of protection. Brushes may be necessary for the removal of certain surface impurities. Soft fiber bristle brushes are recommended.

When dirt has accumulated on older surfaces over an extended period of time, a combination of methods may be necessary to properly clean the stone. A plain water jet, from a power washer, will typically remove most accumulation. Adjust the pressure on the machine accordingly and do not exceed 1,200 Psi, from a 45-degree fan-shaped nozzle, holding the tip no closer than 6 inches to the face of the marble. No chemicals should be used that could be harmful to the marble. Note, however, that even high-pressure water can cause damage. Proper pressure, nozzle size and working distance should be maintained consistently during the process.

MARBLE

CARE AND MAINTENANCE GUIDE

One type of accumulation that can occur on marble, limestone, concrete, and other calcareous materials is algae, which appears to be an accumulation of dirt affected by water flowing over the surface. Algae can be removed by using diluted hydrogen peroxide (1/2 cup in a gallon of water) or vigorously scrubbed over the wetted marble, if necessary. After cleaning with a soft bristle brush, loosened algae can be hosed away without harming the stone's surface.

Avoid direct contact with oil-based materials and metals prone to rusting such as iron, copper, or bronze. In most outdoor applications, with the sources removed, normal sun and rain action will generally remove most stains.

PROTECTIVE COATINGS

To maintain the aesthetic beauty of the original installation, applying an impregnating sealer coating to the marble surface might be required. While it is not a requirement to seal Polycor natural stone, a sealer application may aid in cleaning the surface should it become dirty. Test in an inconspicuous area before applying, and use per the manufacturer's recommendations.

For additional information regarding care and maintenance of marble, consult the Dimension Stone Design Manual, published by the Natural Stone Institute, or visit naturalstoneinstitute.org

This guide offers an organized collection of information or a series of options and is not intended as a specific course of action. This document cannot replace education or experience and should be used in conjunction with professional judgment. Not all aspects of this guide may be applicable in all circumstances.





Stone Collection Chart

PRODUCTS		LIMESTONES			GRANITES		
		INDIANA LIMESTONE - FULL COLOR BLEND™	INDIANA LIMESTONE - FOSSIL BEIGE™	INDIANA LIMESTONE - MAVISE™	CALEDONIA™	EASTERN GRAY™	KODIAK BROWN™
Berkshire™	Thin Veneer	●	●			●	
	Full-Bed	●				●	
Rockford Estate Blend™	Thin Veneer	●	●				
	Full-Bed	●	●				
Vanderbilt Classic™	Thin Veneer	●				●	
	Full-Bed	●			●	●	
Sills	Thin Sills	●				●	
	Full Sills	●				●	
Pavers		●	●	●	●	●	●
XL Pavers		●1			●	●	●
Pattern Pavers	3-Piece	●			●	●	●
	4-Piece	●			●	●	●
Pool Coping	Bull-nosed edge	●					
	Chamfered edge	●	●		●	●	
Steps		●				●	
Treads		●				●	
Garden Walls		●	●				
Wall Caps		●	●			●	
Pillar Caps		●	●2			●	
Fire Pits	Round Fire Pit					●	
	Square Fire Pit					●	

1 - Only available in 1 1/4" thickness
 2 - Only available in 24" x 24"

● Existing items
 ● New items

PRODUCTS		GRANITES		MARBLES		
		PICASSO™	SAINT HENRY BLACK™	GEORGIA MARBLE™ PEARL GREY™	GEORGIA MARBLE™ WHITE CHEROKEE™	SAINT CLAIR™
Berkshire™	Thin Veneer			●3		
	Full-Bed			●3		
Rockford Estate Blend™	Thin Veneer					
	Full-Bed					
Vanderbilt Classic™	Thin Veneer			●		
	Full-Bed		●	●		
Sills	Thin Sills			●		
	Full Sills			●		
Pavers		●	●	●	●	●4
XL Pavers		●	●	●	●	
Pattern Pavers	3-Piece	●	●	●	●	
	4-Piece	●	●	●	●	
Pool Coping	Bull-nosed edge					
	Chamfered edge		●	●		
Steps				●		
Treads						
Garden Walls				●		
Wall Caps				●		
Pillar Caps				●		
Fire Pits	Round Fire Pit					
	Square Fire Pit		●			

3 - 10 1/2" size is not available
 4 - Only available in certain sizes

● Existing items
 ● New items

3/4" and 1 1/4" Paver Chart

		LIMESTONES			GRANITES		
STONES		INDIANA LIMESTONE - FULL COLOR BLEND™	INDIANA LIMESTONE - FOSSIL BEIGE™	INDIANA LIMESTONE - MAVISE™	CALEDONIA™	EASTERN GRAY™	KODIAK BROWN™
Pavers	12 x 12	●	●	●	●	●	●
	12 x 18	●	●	●	●	●	●
	12 x 24	●	●	●	●	●	●
	12 x 36	●	●	●	●	●	●
	18 x 18	●	●	●	●	●	●
	18 x 24	●	●	●	●	●	●
	18 x 30	●	●	●	●	●	●
	18 x 36	●	●	●	●	●	●
	24 x 24	●	●	●	●	●	●
	24 x 30	●	●	●	●	●	●
XL Pavers	24 x 48	●1			●	●	●
	36 x 36	●1			●	●	●
Pattern Pavers	3-Piece (12 x 24, 24 x 24, 24 x 36)	●			●	●	●
	4-Piece (12 x 12, 12 x 24, 24 x 24, 24 x 36)	●			●	●	●
1 - Only available in 1 1/4" thickness							
FINISHES							
	Smooth	●	●	●	●	●	●
	Antique	●		●	●		●
	Bush-hammered	●		●			
	Sandblasted	●		●	●		●
	Thermal				●	●	●
	Waterjet				●	●	●

		GRANITES		MARBLES		
STONES		PICASSO™	SAINT HENRY BLACK™	GEORGIA MARBLE™ PEARL GREY™	GEORGIA MARBLE™ WHITE CHEROKEE™	SAINT CLAIR™
Pavers	12 x 12	●	●	●	●	●
	12 x 18	●	●	●	●	●
	12 x 24	●	●	●	●	●
	12 x 36	●	●	●	●	
	18 x 18	●	●	●	●	●
	18 x 24	●	●	●	●	●
	18 x 30	●	●	●	●	
	18 x 36	●	●	●	●	
	24 x 24	●	●	●	●	●
	24 x 30	●	●	●	●	
XL Pavers	24 x 48	●	●	●	●	
	36 x 36	●	●	●	●	
Pattern Pavers	3-Piece (12 x 24, 24 x 24, 24 x 36)	●	●	●	●	
	4-Piece (12 x 12, 12 x 24, 24 x 24, 24 x 36)	●	●	●	●	
FINISHES						
	Smooth	●	●	●	●	●
	Antique	●	●	●	●	●
	Bush-hammered					
	Sandblasted	●	●	●	●	●
	Thermal	●	●			
	Waterjet	●	●			



Polycor Inc. products are natural. Subtle variations in color and texture do occur and are part of what makes natural stone unique and attractive. We cannot guarantee an exact match to any of the photographic images contained in this document. Polycor Inc.'s continuing attention to product improvement requires that product specifications, technical information, and availability are subject to change without notice.

© 2024 Polycor Inc. All Rights Reserved.



Scan this QR Code to find a dealer.

polycor.com

Contact Us

(+1) 812.287.7500



Our hardscapes and masonry products are quarried and processed in the Canada and the US.

